

solé™

26-46
WIDE TFT-LCD TV
Owner's Manual

VIVID IMAGINATION BRINGS
INNOVATIVE TECHNOLOGY TO LIFE

Please read this manual carefully before operating your set.

SLTV26AS1D
SLTV32AS1D
SLTV37AS1D
SLTV40AS1D
SLTV42AS1D
SLTV46AS1D





Foreword

Caution	3
Important Safety Instructions	4
Precaution	5

Overview

Viewing the Control Panel	10
Viewing the Connecting Panel	11
Viewing the Remote Control	13
Button Description	13
PIP (Picture in Picture)	14
Loading the Batteries	16

Installation

Table Stand Installation (Optional)	17
Speaker Installation (Optional)	18

Connections

Connecting the TV Cable	19
Connecting the VCR	20
Connecting the DVD	21
Connecting the Set Top Box	23
Connecting the PC [D-Sub & DVI]	24
Displayable TV Specification	25

Channel Control

Basic Operation	26
OSD Menu Structure	27
Choosing the Channel Type	28
Storing Channels Automatically	28
Adding or Deleting the Channels	29
Fine Tuning the Channel Reception	29
Editing the Channels	30
Digest Function	31

Picture Control

Changing the Picture Mode	32
Adjusting the User Mode	32
Changing the Color Temperature	34
Changing the Color Enhancer	34
Video NR (Noise Reduction)	35
Changing the Screen Form	35
Selecting the Black Enhancer	36
Position	37
Auto Adjust	37
1366 Mode (Native Mode)	38

Sound Control

Adjusting the Sound Balance	39
Changing the Sound Mode	39
User Adjust	40



Contents

Sound Control

Spatial Effect	40
AVC (Auto Volume Control)	40
MTS (Multichannel Television Sound)	41
Digital Output (HDTV Mode Only)	41

Others Control

Adjusting the Transparency of the OSD Window	42
PIP (Picture in Picture)	42
Changing the Size in PIP	43
Changing the Source in PIP	43
Picture Swap in PIP (Picture in Picture)	44
Position in PIP	44
V-Chip (TV Parental Guidelines)	44
TV Block in V-Chip	45
Movie Block in V-Chip	45
Change Password in V-Chip	46
V-Chip Blocking in V-Chip	46
Advanced	46
Set ID in Advanced	47
Blue Back in Advanced	47
Language in Advanced	47
Front Key Lock in Advanced	47
Film Mode	48
HDTV Setup (HDTV Mode)	49
Time Zone in HDTV Setup (HDTV Mode)	49
Daylight in HDTV Setup (HDTV Mode)	49
HDCCD Setup (HDTV Mode Only)	50

Time Setting

Setting the Current Time	51
Setting the On Time	51
Setting the On Channel	52
Setting the On Volume	52
Setting the Off Time	53
Setting the Sleep Timer	53

OSD Menu Tree	54
---------------------	----

Troubleshooting	59
-----------------------	----

Specification

Specification-32" LCD	60
Specification-37" LCD	61
Specification-37" LCD [Plastic Model]	62
Specification-40" LCD	63
Specification-40" LCD [Plastic Model]	64
Specification-42" LCD	65
Specification-46" LCD	66
Specification-46" LCD [Plastic Model]	67



CAUTION
RISK OF ELECTRIC SHOCK
DO NOT OPEN



CAUTION: TO REDUCE THE RISK OF ELECTRIC SHOCK, DO NOT REMOVE COVER (OR BACK), NO USER-SERVICEABLE PARTS INSIDE. REFER SERVICING TO QUALIFIED SERVICE PERSONNEL.

CAUTION

- TO PREVENT DAMAGE WHICH MAY RESULT IN FIRE OR SHOCK HAZARD.
- DO NOT EXPOSE THIS APPLIANCE TO RAIN OR MOISTURE.
- SHOCK HAZARD DO NOT OPEN.

CAUTION

These servicing instructions are for use by qualified service personnel only. To reduce the risk of electric shock, do not perform any servicing other than that contained in the operating instructions unless you are qualified to do so.

CAUTION

The stand intended for use only with this TV. Use with other apparatus is capable of resulting in instability causing possible injury.



This symbol is intended to alert the user to the presence of uninsulated "dangerous voltage" within the product's enclosure that may be of sufficient magnitude to constitute a risk of electric shock to persons.



This symbol is intended to alert the user to the presence of important operating and maintenance (servicing) instructions in the literature accompanying the appliance.

WARNING

- Apparatus shall not be exposed to dripping or splashing and no objects filled with liquids, such as vases, shall be placed on the apparatus.
- This is Class B product. In a domestic environment this product may cause radio interference in which case the user may be required to take adequate measures.
- To reduce the risk of fire and electric shock, do not expose this product to rain or moisture.

FCC NOTICE

This device has been tested and found to comply with the limits for a Class B device, pursuant to Part 15 of the FCC Rules. These limits are designed to provide reasonable protection against harmful interference in home environment as well as in a commercial, industrial or business environment. This equipment can generate, use and radiate radio frequency energy and, if not installed and used in accordance with the instruction, may cause harmful interference to radio communications. However, there is no guarantee that interference will not occur in a particular installation. If this equipment does cause harmful interference to radio or television reception, which can be determined by turning the equipment off and on, the user is encouraged to try to correct the interference by one or more of the following measures:

- Reorient or relocate the receiving antenna.
- Increase the separation between the equipment and receiver.
- Connect the equipment into an outlet on a circuit different from that to which the receiver is connected.
- Consult the dealer or an experienced radio/TV technician for help.

Changes or modification not expressly approved by the party responsible for compliance could void the user's authority to operate the equipment.

Connecting of peripherals requires the use of grounded shielded signal cables.

- **Always be careful when using your the TV. To reduce the risk of fire, electrical shock, and other injuries, keep these safety precautions in mind when installing, using, and maintaining your machine.**



Read all safety and operating instructions before operating your the TV.

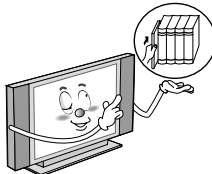

Keep the safety and operating instructions for future reference.

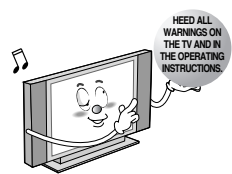

Heed all warnings on the TV and in the operating instructions.



Important Safety Instructions

Always be careful when using your the TV. To reduce the risk of fire, electrical shock, and other injuries, keep these safety precautions in mind when installing, using, and maintaining your machine.

1. Read these instructions.
2. Keep these instructions.
3. Heed all warnings.
4. Follow all instructions.
5. Do not use this apparatus near water.
6. Clean only with a damp cloth.
7. Do not block any of the ventilation openings. Install in accordance with the manufacturer's instructions.
8. Do not install near any heat sources such as radiators, heat registers, stoves, or other apparatus (including amplifiers) that aproduce heat.
9. Do not defeat the safety purpose of the polarized or grounding type plug. A polarized plug has two blades with one wider than the other. A grounding type plug has two blades and a third grounding prong. The wide blade or the third prong is provided for your safety. When the provided plug does not fit into your outlet, consult an electrician for replacement of the obsolete outlet.
10. Protect the power cord from being walked on or pinched particularly at plugs, convenience receptacles, and the point where they exit from the apparatus.
11. Only use the attachments/accessories specified by the manufacturer.
12. Use only with a cart, stand, tripod, bracket, or table specified by the manufacturer, or sold with the apparatus. When a cart is used, use caution when moving the cart/apparatus combination to avoid injury from tip-over.



13. Unplug this apparatus during lightning storms or when unused for long periods of time.
14. Refer all servicing to qualified service personnel. Servicing is required when the apparatus has been damaged in any way, such as power supply cord or plug is damaged, liquid has been spilled or objects have fallen into the apparatus, the apparatus has been exposed to rain or moisture, does not operate normally, or has been dropped.
15. When installing the LCD TV, do not block the appliance coupler with any structure. User can easily have access to the coupler to disconnect it from AC main power.

In case of the following cases, unplug the unit from the wall outlet and contact qualified service center.

- when power supply cord or plug is damaged.
- If liquid has been spilled on the unit or if alien objects have fallen into the unit.
- If the TV has been exposed to rain or water.
- If the TV does not operate normally by following the operating instructions.
- If the TV dropped or the cabinet has been damaged.
- When the TV exhibits a distinct change in performance.

Setting



Follow all operating and use instructions.



Do not use the TV where contact with or immersion in water is a possibility, such as near bath tubs, sinks, washing machines, swimming pools, etc.

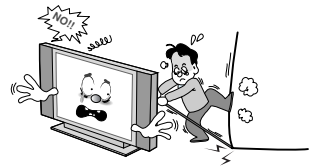

Avoid overhead power lines. An outside antenna system should not be placed in the vicinity of overhead power lines or other electric light or power circuits or where it can fall into such power lines or circuits. When installing an outside antenna system, be extremely careful to keep from touching the power lines or circuits. Contact with such lines can be fatal.

Ground outdoor antennas. If an outside antenna or cable system is connected to the TV, be sure the antenna or cable system is grounded so as to provide some protection against voltage surges and built-up static charges. Section 810 of the National Electrical Code, ANSI/NFPA No.70-1984, provides information about proper grounding of the mast and supporting structure, grounding of the lead-in wire to an antenna discharge unit, size of grounding conductors, location of antenna discharge unit, connection to grounding electrodes, and requirements for the grounding electrode.

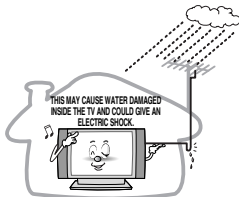

Bend antenna cable between inside and outside building to prevent rain from flowing in.

- This may cause water damaged inside the TV and could give an electric shock.

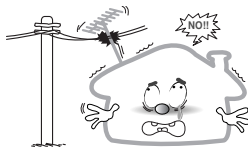

Do not place an outside antenna in the vicinity of overhead power lines, or other electric light or power circuits.

- This may cause an electric shock.

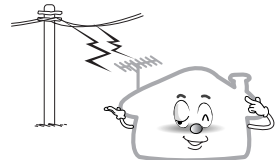

There should be enough distance between an outside antenna and power lines to keep the former from touching the latter even when the antenna falls.

- This may cause an electric shock.

Precaution

Setting

! WARNING



When installing the TV on a table, be careful not to place it too close to the edge of the table.

- This may cause the TV to fall, causing serious injury to a child or adult, and serious damage to the TV.

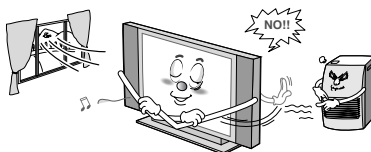

Provide ventilation for the TV. The unit is designed with slots in the cabinet for ventilation to protect it from overheating. Do not block these openings with any object, and do not place the TV on a bed, sofa, rug or other similar surface. Do not place it near a radiator or heat register. If you place the TV on a rack or bookcase, ensure that there is adequate ventilation and that you've followed the manufacturer's instructions for mounting.

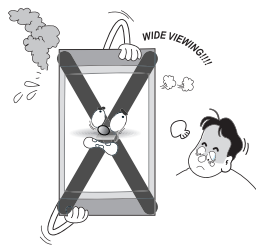

This TV is designed to be mounted horizontally (wide viewing). Any inquiry regarding its vertical position should be forwarded to the manufacture directly.

Precaution

Power

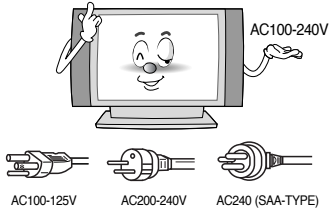
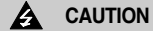

Use only the accessory cord designed for this product to prevent shock. The power supply voltage rating of this product is AC100-240V, the power cord attached conforms to the following power supply voltage. Use only the power cord designated by our dealer to ensure Safety and EMC. When it is used by other power supply voltage, power cable must be changed. Consult your product dealer.

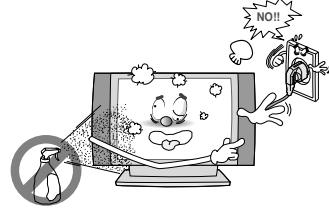

Unplug the TV from the wall outlet before cleaning. Use a damp cloth; do not use liquid or aerosol cleaners.

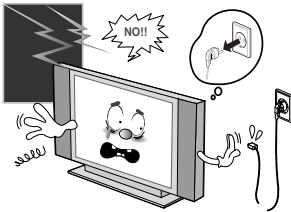

Unplug the TV from the wall outlet and disconnect the antenna or cable system during a lightning storm or when left unattended and unused for long periods of time. This will prevent damage to the unit due to lightning and power-line surges.

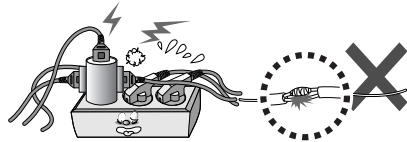

Protect the power cord. Power supply cords should be routed so that they won't be walked on or pinched by objects placed on or against them. Pay particular attention to cords at plugs, convenience receptacles, and the point where they exit from the unit.

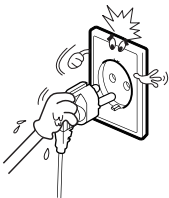

Do not touch the plug with wet hand.
- It can make an electric shock.

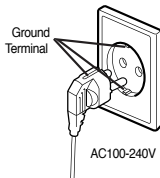

Use only a grounded or polarized outlet. For your safety, this TV is equipped with a polarized alternating current line plug having one blade wider than the other. This plug will fit into the power outlet only one way. If you are unable to insert the plug fully into the outlet, try reversing the plug. If the plug still does not fit, contact your electrician to replace your outlet.

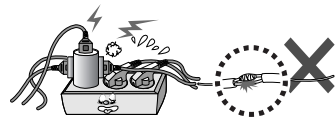

Protect the power cord. Power supply cords should be routed so that they won't be walked on or pinched by objects placed on or against them. Pay particular attention to cords at plugs, convenience receptacles, and the point where they exit from the unit.

Precaution

Operation

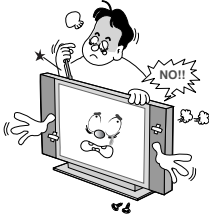

Upon completion of any service or repairs to this TV, ask the service technician to perform safety checks to determine that the TV is in a safe operating condition.

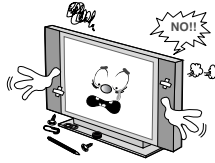

Do not place anything containing liquid on top of the TV.

- This may cause a fire or could give an electric shock.

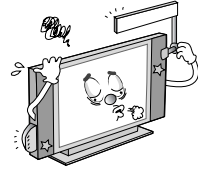

Never add any attachments and/or equipment without approval of the manufacturer. Such additions can increase the risk of fire, electric shock, or other personal injury.

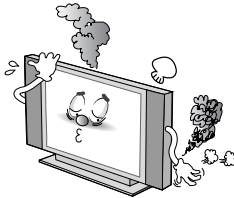

In case of smoke or strange smell from the TV, switch it off, unplug it from the wall outlet and contact your dealer or service center.

- This may cause a fire or could give an electric shock.



Do not insert anything through the openings in the unit, where they can touch dangerous voltage points or damage parts. Never spill liquid of any kind on the TV.

Operation



When replacement parts are required, be sure the service technician uses replacement parts specified by the manufacturer or those that have the same characteristics as the original part. Unauthorized substitutions may result in additional damage to the unit.

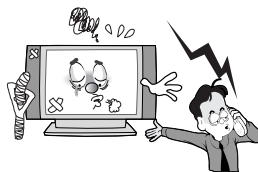

If you make adjustments yourself, adjust only those controls that are covered by the operating instructions. Adjusting other controls may result in damage and will often require extensive work by a qualified technician to restore the TV to normal.



Do not let children hang on or ride on the TV.

Operation

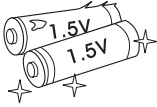

Do not use new battery with old one.

- This can lead a fire or electric shock caused by leakage liquid from abused batteries.

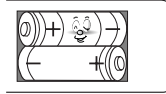

Put the batteries in right direction (+/-).

- Otherwise, it can make a fire, injury and pollution caused by bursting of batteries.

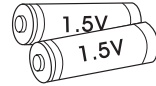

Only use the specified batteries.

- This make cause damaged the TV or could give an electric shock.

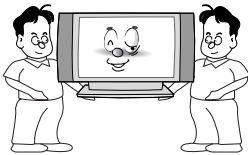

More than two people are necessary to move or take off the package due to the product's weightiness.

- Otherwise, it can cause personal injury.

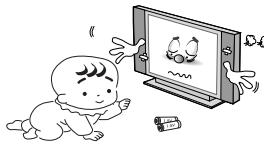

Keep the batteries out of reach of children when exchanged.

- Seek urgent medical advice if child swallows a battery.

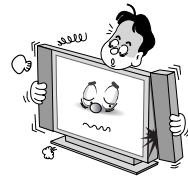

When moving the TV assembled with speakers do not carry holding the speakers.

- This may cause the TV to fall, causing serious injury to a child or adult, and serious damage to the TV.

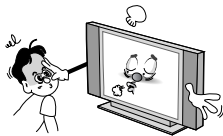

The distance between eyes and the screen should be about 5-7 times as long as diagonal length of the screen.

- If not, eyes will strain.

Viewing the Control Panel

OSD Button Position

Front Panel

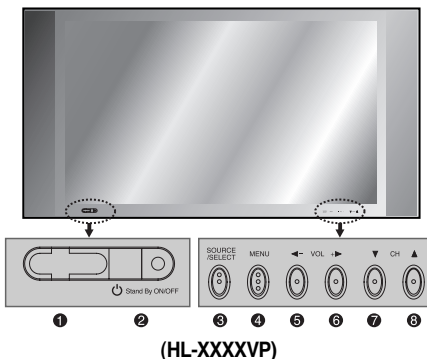
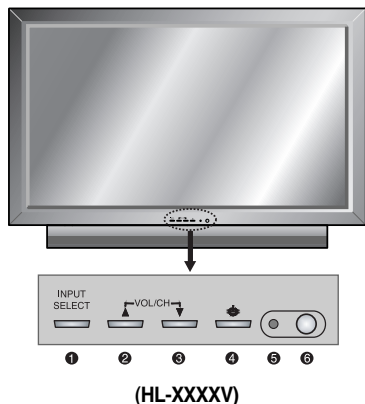

OSD Button

- | | |
|------------------------------|-----------------|
| ① Input Source Select | ① Stand By |
| ② Up (See the box below) | ② Remote Sensor |
| ③ Down (See the box below) | ③ Source/EXIT |
| ④ Stand By | ④ Menu/SET |
| ⑤ Remote Sensor | ⑤ VOL- |
| ⑥ Status/Power Indicator LED | ⑥ VOL+ |
| | ⑦ CH- |
| | ⑧ CH+ |

OSD Button Function

INPUT SELECT

Select the signal source from multiple input sources such as TV, SCART1, SCART2, S-VIDEO/AV, COMPONENT1, COMPONENT2, PC, DVI and HDMI.

VOL/CH ▲/▼ (HL-XXXXV) OR VOL/CH -/+ (HL-XXXXVP)

To change the **CHANNEL**, press ▼ button first and change the channel with ▲, ▼ buttons.

To change the **VOLUME**, press ▲ button first and change the volume with ▲, ▼ buttons. (HL-XXXXV Only)

To change the **CHANNEL** and **VOLUME**. (HL-XXXXVP Only)

Stand By ON/OFF

Turn the TV on and off.

Menu (HL-XXXXVP Only)

Call the OSD Menu.

Accessories



Remote Control Handset



Power Cord



RF Cable (Optional)



Alkaline Batteries



Owner's Manual

Viewing the Connecting Panel

Back Panel and Jacks

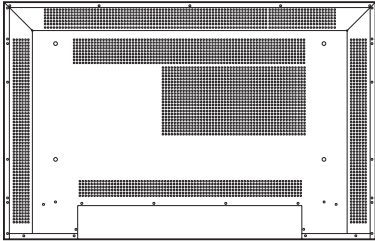

Back panel of the TV

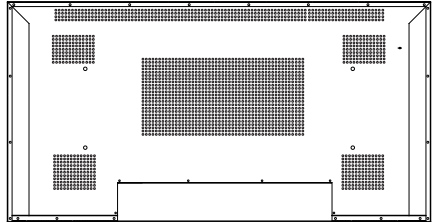

Back panel of the TV

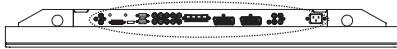

(HL-XXXXV)

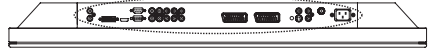

(HL-XXXXVP)

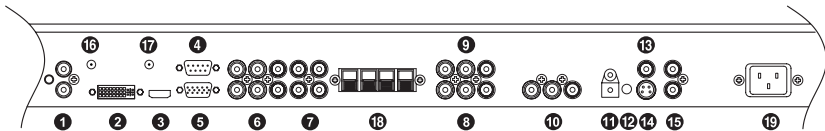

❶	DVI & D-Sub (PC) Sound	❶❶	SPDIF (Optical)
❷	DVI	❶❷	Line Out
❸	HDMI	❶❸	AV
❹	RS-232C	❶❹	S-VIDEO
❺	D-Sub (PC)	❶❺	S-VIDEO/AV Sound
❻	COMPONENT1, 2	❶❻	A-TV Antenna
❼	COMPONENT Sound1, 2	❶❼	D-TV Antenna
❽	VIDEO1	❶❽	Speaker (HP-XXXXV Only)
❾	VIDEO OUTPUT2	❶❾	AC Power
❿	VIDEO2		

Viewing the Connecting Panel

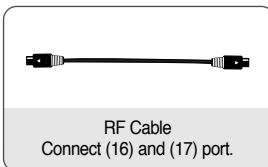
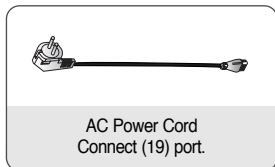
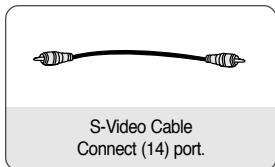
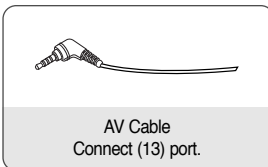
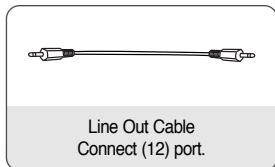
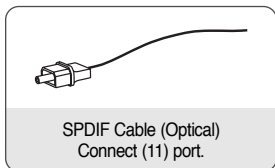
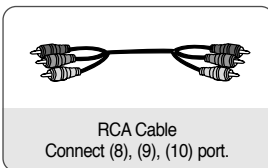
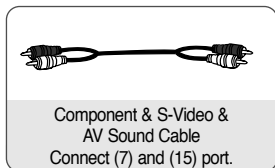
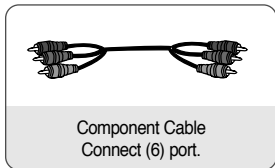
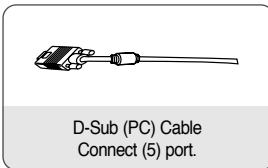
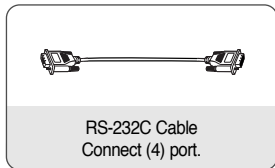
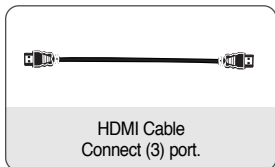
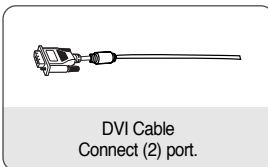
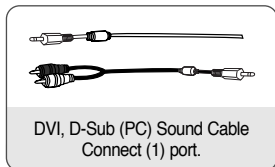

Connectors	
Audio Input	RCA Pin Jack
Composite Video Input	RCA Pin Jack
Composite Video Output	RCA Pin Jack
S-VIDEO Input	Mini Din 4Pin
Component Video Input	RCA Pin Jack
Analog RGB Input	Mini D-Sub 15Pin
HDMI Input	HDMI Connect
Digital Video Input	DVI-D 24Pin

• Cables connecting the PC vary according to the type of machine, so consult your product dealer.

RS-232C Configurations			
3-Wire (Non-standard)			
	PC	TV	
RXD	2	3	TXD
TXD	3	2	RXD
GND	5	5	GND
DTR	4	4	DTR
DSR	6	6	DSR
RTS	7	7	RTS
CTS	8	8	CTS

Viewing the Remote Control

Button Description

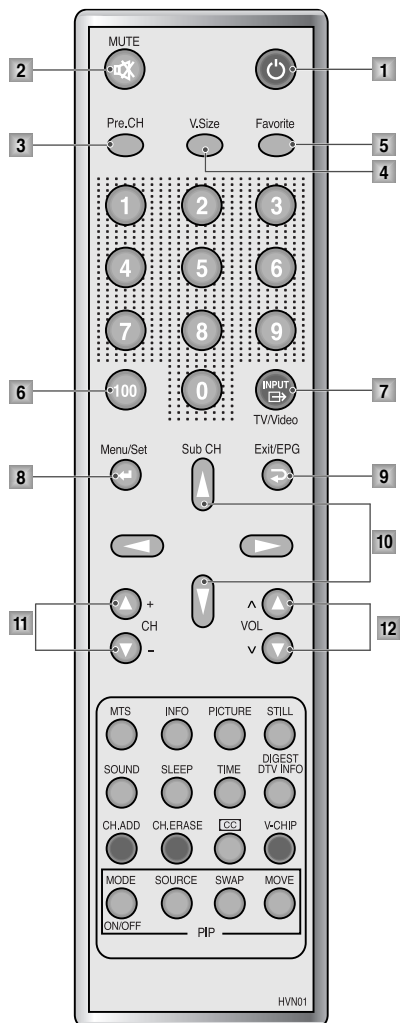

- 1 Stand By**
Turn the TV on and off.
- 2 MUTE**
Temporarily cut the sound and restore it.
- 3 Pre.CH**
Turn to the previous program or exit OSD.
- 4 V.Size**
Choose the Screen Form.
16:9 → 4:3 → Panorama → Zoom1 → Zoom2
- 5 Favorite**
Tune to your next favorite program.
- 6 100**
Display to tune the channels over 100.
- 7 INPUT**
Display the input source list.
- 8 Menu/Set**
Display the main OSD menu.
Activate your choice in the OSD menu.
- 9 Exit/EPG**
Return to the previous OSD menu.
- 10 Sub CH**
Change channels of the sub window by pressing the Sub CH button and CH+/- button after pressing this button in PIP.
- 11 CH+/CH-**
Move to the upper or lower channel.
- 12 VOL ^/VOL v**
Increase or decrease the volume level.



Notice

EPG (Electronic program guide) on Remote (HDTV mode only):
Perform the function showing channel information. (Title, Time slot)

Viewing the Remote Control

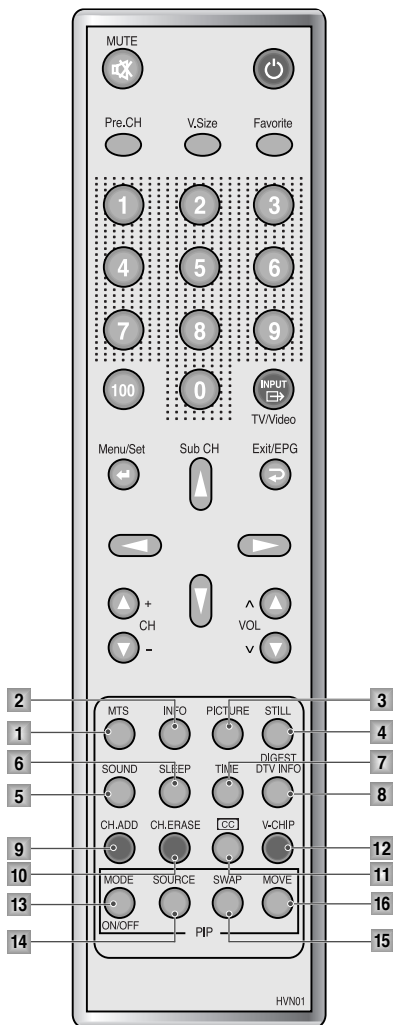

Notice

DTV Info (HDTV mode only): Perform the function showing current channel information. (Title, Time slot, Closed caption, Dolby)

- 1 MTS**
Choose the MTS (Stereo) mode.
Each time it is pressed, different mode is selected.
Mono → Stereo → SAP
• You can select only available modes depending on the source.
- 2 INFO**
Display the current information about time, screen form, source and MTS mode.
- 3 PICTURE**
There are 4 picture modes.
Standard → Vivid → Mild → User
- 4 STILL**
Temporarily freeze the screen and restore it.
- 5 SOUND**
Choose the sound equalizer settings.
Standard → Movie → Music → News → User
- 6 SLEEP**
Set the preset time interval for automatic turn - off.
OFF (Not work) → 10 min. → 20 → 30 → 60 → 90 → 120 → 150 → 180
- 7 TIME**
Display the current time on the screen.
- 8 DIGEST/DTV INFO**
Display 16 TV programs at the same time.
- 9 CH.ADD**
Add the current channel to memory.
- 10 CH.ERASE**
Erase the current channel to memory.
- 11 CC (CLOSED CAPTION)**
Set the close caption.
Off → Caption CC1 → Caption CC2 → Caption Text1 → Caption Text2
- 12 V-CHIP**
Get into V-Chip menu.

▶ PIP (Picture in Picture) Buttons

- 13 MODE (On/Off)**
Activate PIP function and change the PIP window size and PIP mode.
Small → Large → Twin (Half) → OFF
- 14 SOURCE**
Change the PIP window source.
- 15 SWAP**
Swap the main screen and the PIP window.
- 16 MOVE**
Move the position of the PIP window.

Viewing the Remote Control

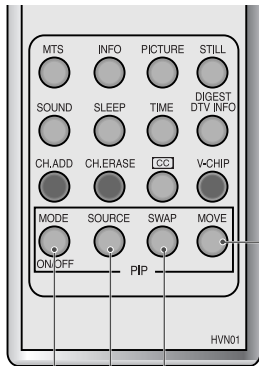

MOVE button: Move the position of PIP window.

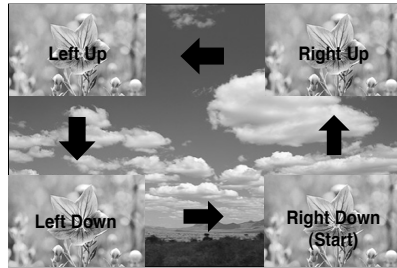

SWAP button: Swap the sources of the main screen and PIP window.



MODE button: Change the PIP window mode.
OFF → Small → Large → Twin



SOURCE button: Change the source of the PIP window. The available sources are shown as below.

PIP \ Main	TV	HDTV	VIDEO1	VIDEO2	S-VIDEO/AV	COMPONENT1	COMPONENT2	PC	DVI	HDMI
TV	-	✓	✓	✓	✓	✓	✓	✓	✓	✓
HDTV	✓	-	✓	✓	✓	✓	-	✓	✓	✓
VIDEO1	✓	✓	-	✓	✓	✓	✓	✓	✓	✓
VIDEO2	✓	✓	✓	-	✓	✓	✓	✓	✓	✓
S-VIDEO/AV	✓	✓	✓	✓	-	✓	✓	✓	✓	✓
COMPONENT1	✓	✓	✓	✓	✓	-	✓	✓	✓	✓
COMPONENT2	✓	-	✓	✓	✓	✓	-	✓	✓	✓
PC	✓	✓	✓	✓	✓	✓	✓	-	-	-
DVI	✓	✓	✓	✓	✓	✓	✓	-	-	-
HDMI	✓	✓	✓	✓	✓	✓	✓	-	-	-

Viewing the Remote Control

Loading the Batteries

- 1 Press on the cover and slide in the direction of the arrow.
- 2 Load two AAA batteries, taking care that the + and - ends face the correct direction.
- 3 Close the cover until it clicks.

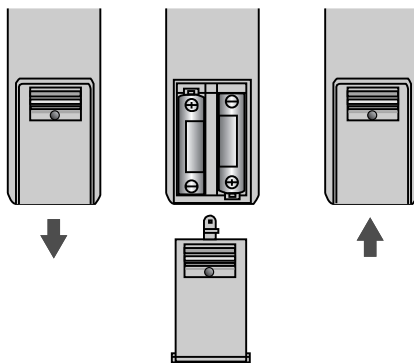

Reception Range of Remote Control

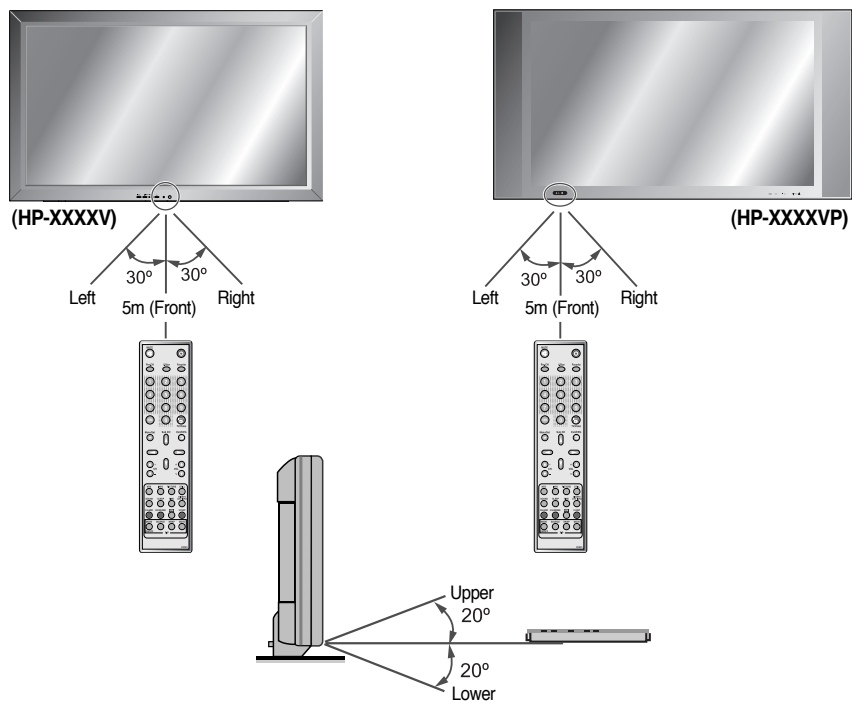
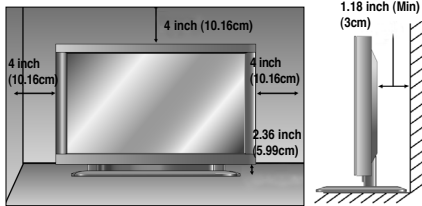

Table Stand Installation (Optional)



< The TV can be installed on the desk as shown above. >



- Table stand mount minimum allowable clearances for adequate ventilation.

Wall Mount Installation (Optional)



< The TV can be installed on the wall as the picture above. >

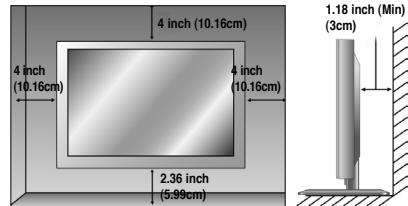

- Install this TV only in a location where adequate ventilation is available.

Installation

Table-Stand User's Guide

1. Lay the set down.
2. Fit the set with the stand.
4. Ⓐ -Screw Up (4 x 12)

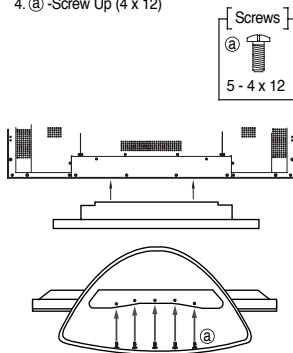
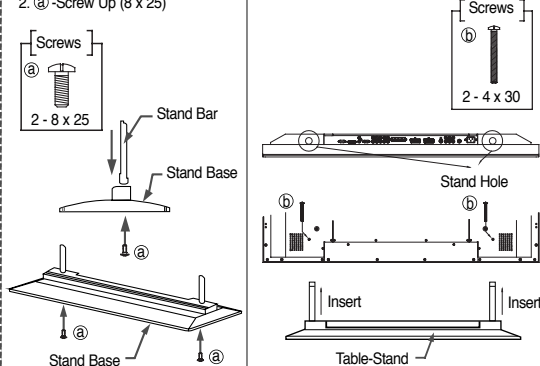

Table-Stand User's Guide

1. Insert Stand Bars into the Stand Base as shown below.
2. Ⓐ -Screw Up (8 x 25)
3. Insert a Table-Stand as below.
4. Ⓑ -Screw Up (4 x 30)





Installation

Speaker Installation (Optional) (HL-XXXXV Only)

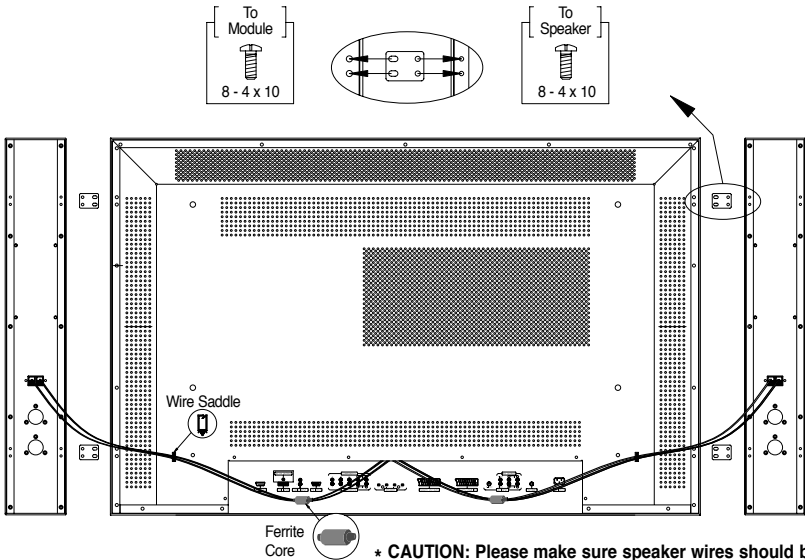

Caution

- **Be sure TV power is turned off before making any connections.**
Place the speakers in the position you want. Install the speaker wires on the TV and speaker. Be sure to connect the positive "+" wire to the "+" input and the negative "-" wire to the "-" input. Connect left TV input to left speaker and right TV input to right speaker. Any extra speaker wire length remaining can be bunched into the wire holders provided. (Caution: Once installed, the speaker wire holders lock into position and can't be removed.)
- **Always lift the TV itself (not the speakers) when handling or moving the TV after speakers have been installed.**

Speaker Accessories



4 - Iron Plates
(Mount speakers to TV)



16 - 4 x 10 Long Bolts
(Attach iron plates to speakers)



2 - Speaker Wire Holders
(For arranging the speaker wires)



2 - Speaker Wires

Connecting the TV Cable

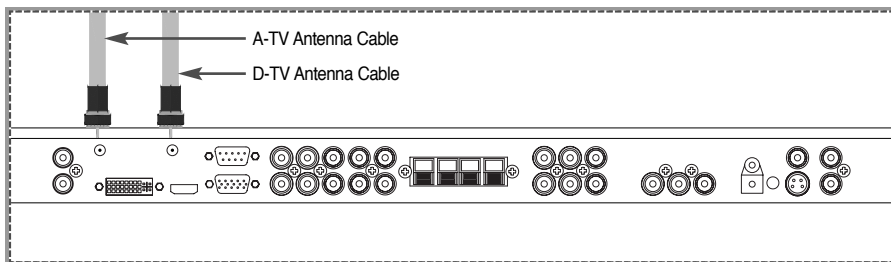

HL-XXXXV

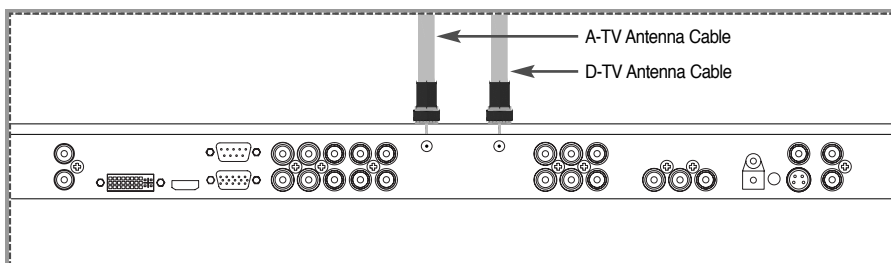

HL-XXXXVP

Connection the TV Cable

- 1 Connect the TV Antenna cable to the TV input jack. Press INPUT button on the remote control and select TV or HDTV on OSD.
- 2 Use CH+, CH- button or numeric button to change TV program for your program selection.
- 3 Press Pre.CH button on the remote control to tune the previous program.
- 4 Also, you can tune to cable service provided programs using the cable box. For further information regarding cable TV service, contact cable TV service provider(s).

Connecting the VCR

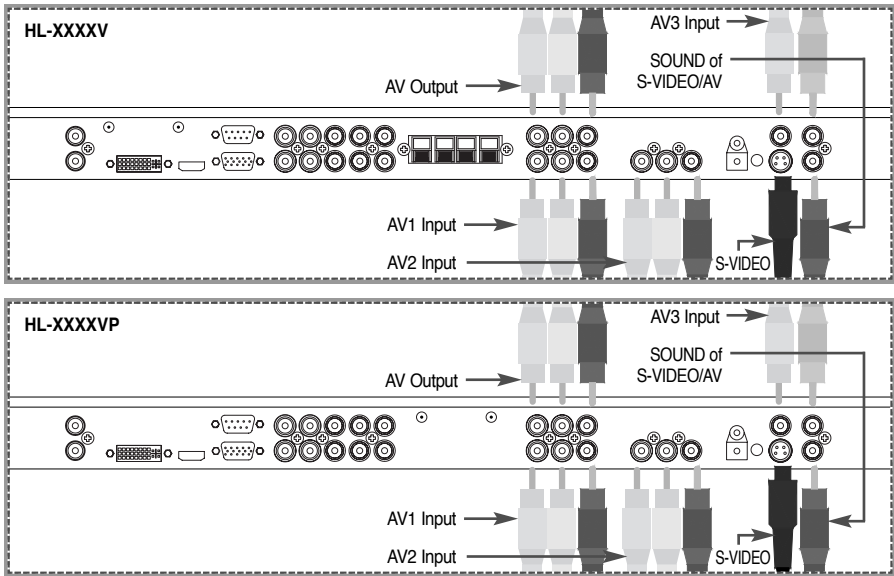

Connecting the VCR

With S-VIDEO

Connect a S-Video cable to the S-Video jacks of the VCR and the TV.

Connect L (White), R (Red) sound cable (Composite) to the sound jacks of the VCR and the TV.

With AV Input

Connect a composite cable to the AV video jacks of the VCR and the TV.

Connect L (White), R (Red) sound cable (Composite) to the sound jacks of the VCR and the TV.

Watching VCR

- 1 Press INPUT button on the remote control and select video sources.
- 2 Insert a video tape into the VCR and press the PLAY button on the VCR.



Notes

- **To avoid picture noise** (interference), leave an adequate distance (over 3m) between the VCR and TV.
- When connecting the TV with external equipment, match the colour of connecting ports (e.g. Video -Yellow, Audio(L) - White, Audio(R) - Red).
- If you have a mono VCR, connect the audio cable from the VCR to the AUDIO (L/Mono) input of the TV.
- If you connect an S-VHS VCR to the S-VIDEO input socket, you can get a better picture quality than normal video input (AV).
- **Avoid having a fixed image remain on the screen for a long period of time.**
Typically a frozen still picture from a VCR 4:3 picture format or if a program information is present.

Connecting the DVD

Connecting the DVD

- Connect the three separate component video cables to the DVD player's Y, Pb and Pr jacks and to the component jacks on the TV.
- Connect the audio cable to the DVD player's audio L (White) and R (Red) jacks and to the L and R audio jacks beside the component jacks on the TV.
- Connect the HDMI cables to the DVD player's and to the HDMI cables on the TV.

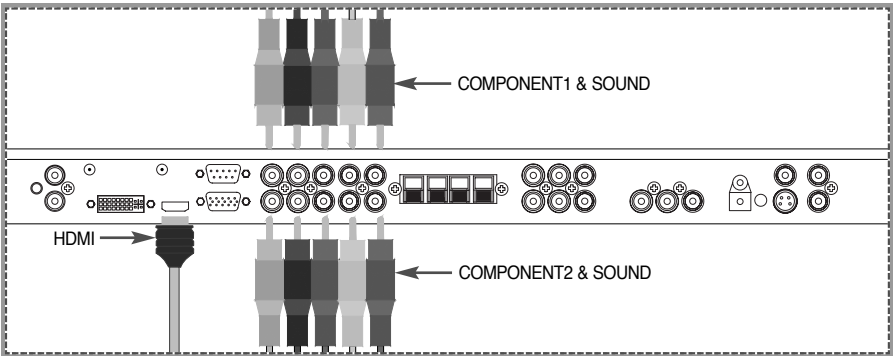

HL-XXXXV

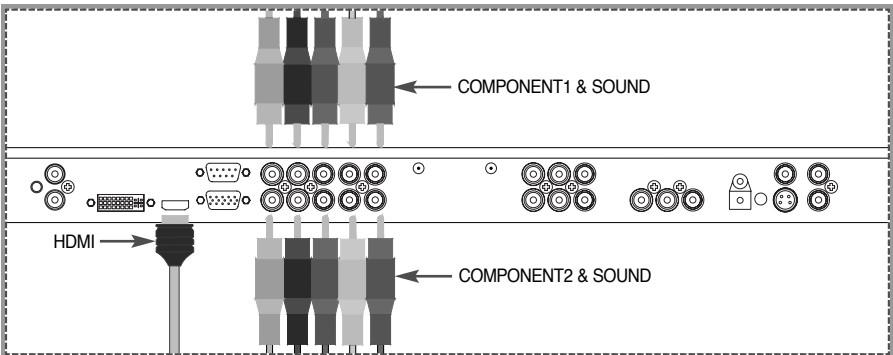

HL-XXXXVP

Connecting the DVD

How to Use

- 1 Turn on the DVD player.
- 2 Press INPUT button on the remote control of the TV and select HDMI, COMPONENT1 or COMPONENT2.

Component Input Ports

You can get better picture quality if you connect DVD player with component input sockets as below.

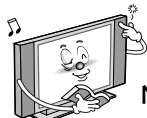

Notice

- Normal DVD source is based on 480i, which should be through normal Y Pb Pr of component signal. It may occur screen noise, blank screen in case of using HDMI Cable unauthorized by ATC. It may easily occur as specially HD signal (720p or 1080i) input. Suggest HDMI Cable only authorized by ATC.

	Supported Signals				
	COMPONENT1	COMPONENT2	PC	DVI	HDMI
480i/60Hz	✓	✓	-	-	-
480p/60Hz	✓	✓	✓	✓	✓
576i/50Hz	✓	✓	-	-	-
576p/50Hz	✓	✓	✓	✓	✓
720p/50Hz	✓	✓	✓	✓	✓
720p/60Hz	✓	✓	✓	✓	✓
1080i/50Hz	✓	✓	✓	✓	✓
1080i/60Hz	✓	✓	✓	✓	✓

Component ports of the TV	Y	P _B	P _R
Video output ports of DVD player	Y Y Y	P _b B-Y C _b P _b	P _r R-Y C _r P _r

What is HDMI?

HDMI™

HIGH-DEFINITION MULTIMEDIA INTERFACE

- HDMI, or high-definition multimedia interface, is a next-generation interface that enables the transmission of digital audio and video signals using a single cable without compression.

- "Multimedia interface" is a more accurate name for it especially because it allows Not Only Digital video but also digital audio. The difference between HDMI and DVI is that the HDMI device is smaller in size, has the HDCP (High Bandwidth Digital Copy Protection) coding feature installed, and supports multi-channel digital audio.
- Use the HDMI/DVI terminal for DVI connection to an extended device. You should use the DVI-to-HDMI cable or DVI-HDMI Adapter for the connection.
- HDMI, the HDMI logo and High-Definition Multimedia Interface are trademarks or registered trademarks of HDMI Licensing LLC.

Connecting HDMI/DVI

- Supports connections between HDMI-connection-enabled AV devices (set top boxes, DVD players, AV receivers and digital TVs).
- No sound connection is needed for an HDMI to HDMI connection.

Connecting the Set Top Box

How to Connect

Connect set top box video inputs to AV, COMPONENT, HDMI, PC or DVI jacks on the TV.
Audio inputs to Audio sockets beside the L (White) and R (Red) audio jacks which you connect video inputs.

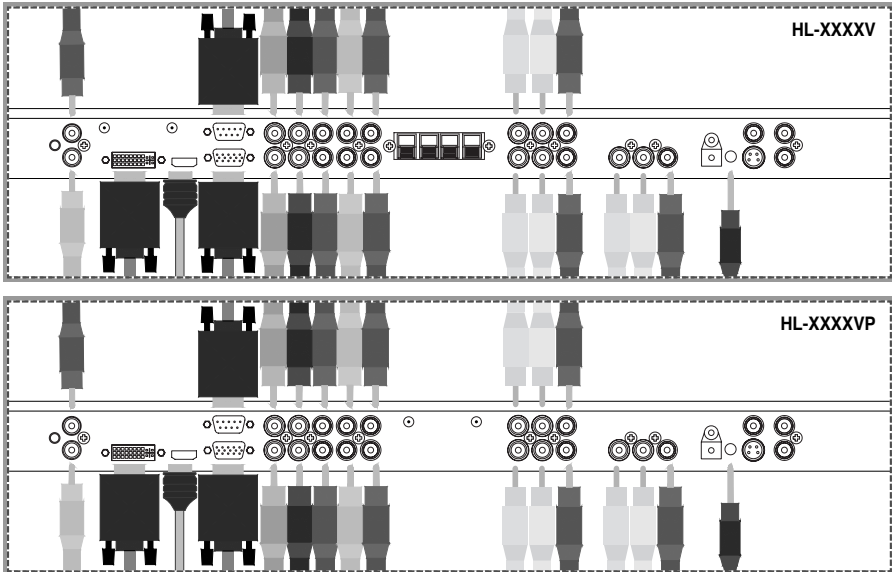

How to Use

- 1 Turn on the set top box.
- 2 Press INPUT button on the remote control of the TV and select COMPONENT1, COMPONENT2, HDMI, PC or DVI.

How to Connect

With AV

Connect a AV cable to the AV jacks of the STB (set top box) and the TV.

With COMPONENT

Connect a three separate component cables to the component jacks of the STB and the TV.
Connect L (White) and R (Red) sound cables (Composite) to the sound jacks of the STB and the TV.

With HDMI

Connect a HDMI cable to the HDMI jacks of the STB and the TV.

With RGB or DVI

Connect a D-Sub or DVI cable to the AV video jacks of the STB and the TV.
Connect L (White) and R (Red) sound cables (Composite) to the sound jacks of the STB and the TV.

	Supported Signals				
	COMPONENT1	COMPONENT2	PC	DVI	HDMI
480i/60Hz	✓	✓	-	-	-
480p/60Hz	✓	✓	✓	✓	✓
576i/50Hz	✓	✓	-	-	-
576p/50Hz	✓	✓	✓	✓	✓
720p/50Hz	✓	✓	✓	✓	✓
720p/60Hz	✓	✓	✓	✓	✓
1080i/50Hz	✓	✓	✓	✓	✓
1080i/60Hz	✓	✓	✓	✓	✓

Connecting the PC (D-Sub & DVI)

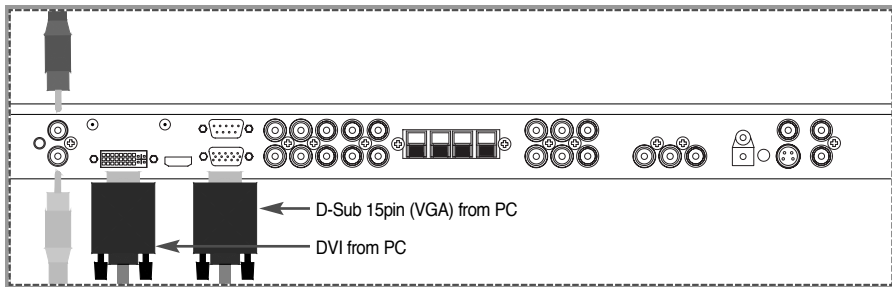

HL-XXXXV

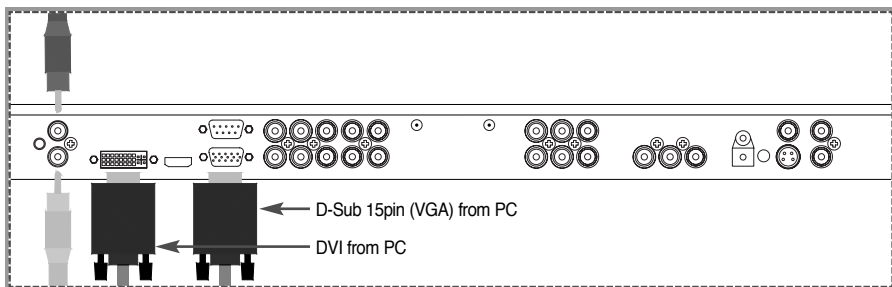

HL-XXXXVP

▶ Connecting a PC to the TV

Connect a PC (15pin) video cable between the video output port on the PC and the PC port on the TV.

▶ Pin Configuration

15pin signal cable (based on protruded pin).

▶ To watch the PC screen

- 1 Turn on the TV and press INPUT button to select the PC mode.
- 2 Turn on the PC and check for the PC requirement.
- 3 Adjust the PC screen in Position menu. (See 37 page.)



Notes

- DVI Port support DVI-D. (*DVI-D receive only digital signal)



Pin No.	Description
1	Red (R)
2	Green (G)
3	Blue (B)
4	Grounding
5	Grounding (DDC)
6	Red (R) Grounding
7	Green (G) Grounding
8	Blue (B) Grounding
9	Reserved
10	Sync Grounding
11	Grounding
12	Data (DDC)
13	Horizontal sync.
14	Vertical sync.
15	Clock (DDC)

Displayable TV Specification



Resolution	Horizontal Frequency (KHz)	Vertical Frequency (Hz)
720 x 400	31.469	70.08
	37.927	85.03
640 x 480	31.469	59.94
	35.000	66.66
	37.861	72.80
	37.500	75.00
	43.269	85.00
	45.913	90.03
	53.011	100.04
800 x 600	35.156	56.25
	37.879	60.31
	48.077	72.18
	46.875	75.00
	53.674	85.06
	56.000	90.00
	64.016	100.00
832 x 624	49.725	74.55
1024 x 768	48.363	60.00
	56.476	70.06
	60.023	75.029
	68.677	84.997
1152 x 864	67.50	75.00
1280 x 1024	64.00	60.00



Notes

- **Synchronization input form: separate**
- The TV recognizes 640 x 480 @60Hz signal as 480p DTV signal.
So the signal is expanded, please try other signals like 640 x 480 @75Hz.
- The TV operates abnormally if a non-standard video format is selected.
- Depending on the manufacturer, your PC screen might appear differently (and depending on your particular version of Windows).
Check your PC instruction book for information about connecting your PC to a the TV.
- The TV may operate abnormally if a non-standard video signal inputs.
- **"Not Support"** message box will appear when an over-spec video signal is inputted.
Change the video settings of PC when the message is displayed.

Basic Operation

Turning the TV ON/OFF



Press the Power button on the remote control. The TV will turn on and you will be ready to use its features. You can also use the Power button on the front panel.

Select Source

Press INPUT button on the remote control. Then you can see the source list menu shown as below.



Source list menu

Select the source to watch with  /  button on the remote control and press the Menu/Set button.

TV Program Selection

- 1 Connect the signal source (TV antenna) to TV input. Press INPUT button on the remote control and select TV on the source list.
- 2 Use CH+/CH- button or numeric button to change TV program you want.
- 3 Press Pre.CH button on the remote control to watch the previous program.
- 4 Also, you can tune the cable service, provided programs while using the cable box. For further information regarding cable TV service, contact your TV service provider(s).

Volume Control

Use VOL ^ /VOL v button on the remote control to adjust the volume level. Press MUTE button on the remote control when you need to cut the sound temporarily.

OSD Menu Structure

- OSD (On Screen Display) allows users to control or adjust various features and settings in accordance with his/her preferences.
- Press the Menu/Set button on the remote control to see the main OSD menu.

Example of OSD Menu

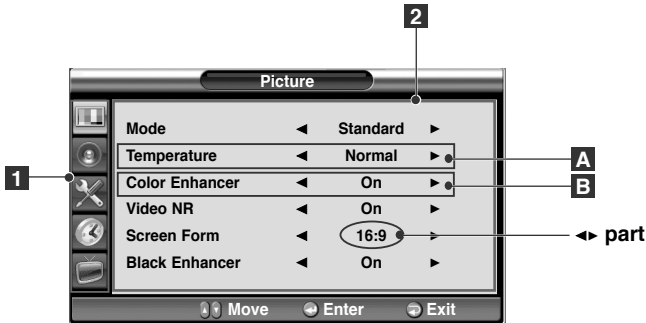

1 Main Menu

Press Menu/Set button on the remote control to enter the main OSD menu.

First, select main menu item you need with button.

To select a main menu items, just press Menu/Set button on the remote control.

2 Sub Menu

Each menu item has its own sub menu items to set.

3 Sub Menu Items

A: If there is no part, the item has an sub menu.

You can enter the sub menu and adjust an item you need.

Select sub-menu item with button on the remote control and press Menu/Set button to enter the sub menu.



B: If there is a part, you can set the item by selecting . Ex) ON or OFF .

Press Menu/Set button to set a part, and adjust it with button.

Setting the Channel (ATV)



Choosing the Channel Type

Before your television can begin memorizing the available channels, you must specify the type of signal source that is connected to the TV. (i.e., an antenna, a standard cable system).

- 1 Press Menu/Set button to display the main OSD menu.
- 2 Select the TV main menu.
- 3 Press Menu/Set button to enter the sub menu.
- 4 Select **Channel Type(ATV)** or **Channel Type(DTV)**.
- 5 Select the **Channel Type(ATV)** Menu/Set button and press Exit button. You can select Channel Type(Air/Cable) and System Type(NTSC/PAL-M) in Sub Menu "Channel Type".
- 6 Select the **Channel Type(DTV)** with  /  button and press Exit button. You can select directly Air / CABLE / HRC / IRC.



Storing Channels Automatically

- 1 Press Menu/Set button to display the main OSD menu.
- 2 Select the TV main menu.
- 3 Press Menu/Set button to enter the sub menu.
- 4 Select **Auto Scan** with  /  buttons and press Menu/Set button on the remote control. Then the tuning bar will appear and scanning will start.

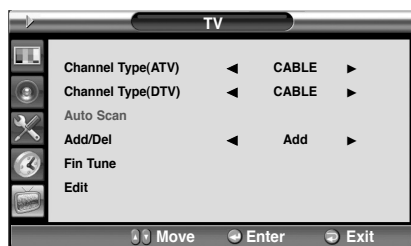

(HDTV Scan)



(ATV Scan)

Setting the Channel (TV)



Notes

Analog Scan precedes Digital Scan on Auto Scan mode.

- You can enter the TV menu and HDTV menu in TV mode only. (When you watch a TV program.)
- ATV: Analog TV
- DTV: Digital TV (ATSC)

Adding or Deleting the Channels

You can add or erase the current channel.

- 1 Press Menu/Set button on the remote control to display the main OSD menu.
- 2 Select the TV main menu with / button on the remote control.
- 3 Press Menu/Set button to enter the sub menu.
- 4 Select **Add/Del** menu.
- 5 Select the **Add/Del** with / button and press Exit button. You can select Add/Del.



Notes

- Only scanned programs can be stored as Favorite programs.

Fine Tuning the Channel Reception

The fine tuning function lets you manually adjust the TV's tuner if you have difficulty tuning analog channels.

- 1 Press Menu/Set button to display the main OSD menu.
- 2 Select the TV main menu.
- 3 Press Menu/Set button to enter the sub menu.
- 4 Select **Fine Tune** with / button and press Menu/Set button. Then you can see the adjust bar.
- 5 Adjust the Fine Tune with / button.



Fine Tune only operates on TV mode.





Setting the Channel (TV)

Editing the Channels

▶ Edit Favorite Program list

You can store of your favorite channels for each available input source. Then, when you press the Favorite button on the remote control, the TV display only the favorite channels you previously stored, allowing you to quickly and easily find frequently wanted channels.

- 1 Press Menu/Set button to display the main OSD menu.
- 2 Select the TV main menu.
- 3 Press Menu/Set button to enter the sub menu.
- 4 Select **Edit** and press the Menu/Set button.
- 5 Select the channel to skip or set as the favorite channels.
- 6 Select CH and set the values with  /  button on the remote control.



DTV	ATV	
	Skip	Fav
CH		
8	Yes	No
9	Yes	No
10	Yes	No
11	Yes	No
12	Yes	No
13	Yes	No
14	Yes	No
15	Yes	No
16	Yes	No
17	Yes	No

At the bottom of the table, there are three buttons: "Enter", "Ch Move", and "Exit".

You can add or erase the current channel by the remote control.

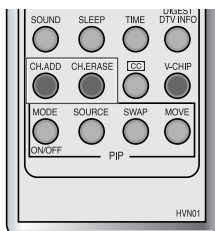

CH ADD

Add the current channel into the scanned channel list.

CH ERASE

Remove the current channel from the scanned channel list.



Notes

Only scanned channels can be set as favorite channels.

Setting the Channel (TV)

▶ Digest Function

With the Digest function, you can select a TV program watching 16 program at once. This function works in TV mode only.

- 1 Press the DIGEST button on the remote control.
- 2 You can make off the Digest Function by pressing DIGEST button again.

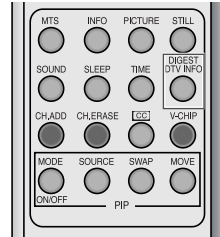

16 side windows are renewed clockwise.
Next memorized program appear in the renewed windows.

To choose the program, press the channel number with the numeric buttons on the remote control.

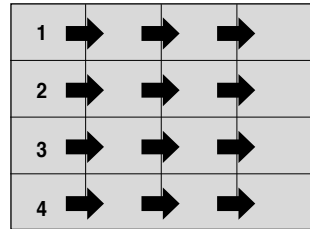

Setting the Picture

Changing the Picture Mode

Your the TV has 3 automatic factory preset picture settings (**Standard**, **Vivid** and **Mild**). You can choose **Standard**, **Vivid** or **Mild** by pressing Picture button on the remote control (or by making a selection from the menu). Or you can select **User** which automatically recalls your personalized picture settings.

- 1 Press Menu/Set button to display the main OSD menu.
- 2 Select the Picture main menu.
- 3 Press Menu/Set button to enter the sub menu.
- 4 Select **Mode** and press Menu/Set button to enter the sub menu. Then the picture sub mode appear.
- 5 Select the picture mode and press Menu/Set button.
- 6 You will see the picture setting bars. Just press Exit button on the remote control. You can adjust each values of the picture setting, but the changed values are stored as in **User** mode.

**User mode require more settings.
It has an under menu.**



Notes

Alternative method: Just press the Picture button on the remote control. Each time it is pressed, different mode is selected.

Adjusting the User Mode

You can change the **Contrast**, **Brightness**, **Color**, **Sharpness** and **Tint** according to personal preference in **User** mode. (The function for Tint adjustment is activated when NTSC signal is input.)

- 1 Select the item to adjust with / button.
- 2 Press Menu/Set button.
- 3 Adjust the item with / button.
- 4 To cancel all adjust, select **Recall** and press Menu/Set button.

For a more detailed description of these settings, see the next page.

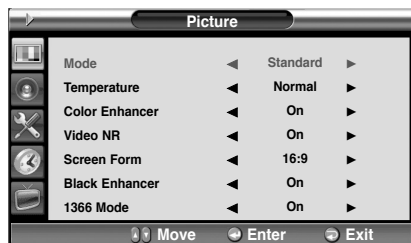

Select User Mode



Setting the Picture

▶ Contrast

Adjust brightness difference between bright part of the screen and dark part.

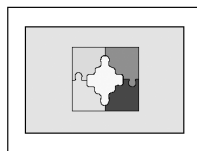

Distinct ◀

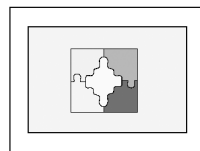

▶ Vague

▶ Brightness

Adjust brightness of the screen.

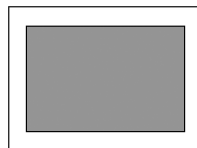

Dark ◀

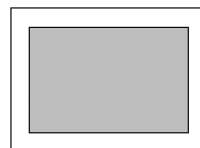

▶ Bright

▶ Color

Adjust deep and light color of the screen.



Decrease ◀



▶ Increase

▶ Sharpness

Adjust vividness of the screen.



Less sharp ◀



▶ Sharp

▶ Tint

Adjust the balance between green and yellow.



Green color is deeper ◀





▶ Red color is deeper

Setting the Picture

Changing the Color Temperature

Your TV has 5 screen temperatures (color settings).

- 1 Press Menu/Set button to display the main OSD menu.
- 2 Select the Picture main menu.
- 3 Press  button to enter the picture menu.
- 4 Select **Temperature** and press Menu/Set button to enter the sub menu. Then the picture-temperature under menu appear.
- 5 Select the Temperature mode with  button and press Menu/Set button.
- 6 Press Exit button to return.

▶ Cool 1, 2

Screen seems cool: Strong Blue.

▶ Normal

Normal: Factory default.

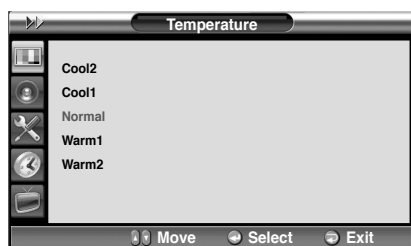
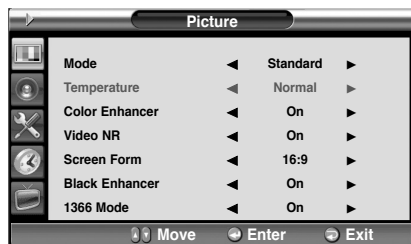

▶ Warm 1, 2

Screen seems warm: Strong Red.



Changing the Color Enhancer

This function will enhance the color level. Green, Blue and Skin color on the picture will enhance, while others areas remain unchanged.

- 1 Press Menu/Set button to display the main OSD menu.
- 2 Select the Picture main menu item.
- 3 Press  button to enter the sub menu.
- 4 Select **Color Enhancer**. Then the cursor moves into the  parts.
- 5 Turn on or off Film Mode function with  button and press Exit button.

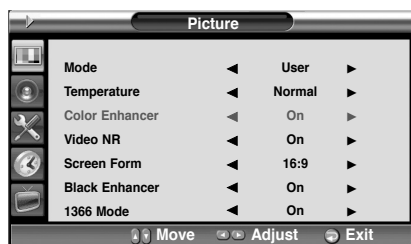

Setting the Picture

Video NR (Noise Reduction)

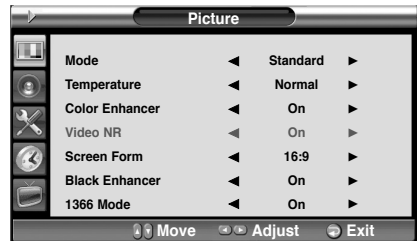

This function automatically filters out and reduces the image noise and improves picture quality where receiving weak signals.

- 1 Press Menu/Set button to display the main OSD menu.
- 2 Select the Picture main menu item.
- 3 Press Menu/Set button to enter the sub menu.
- 4 Select **Video NR**. Then the cursor moves into the ◀▶ parts.
- 5 Turn on or off Video NR function with  button and press Exit button.



Changing the Screen Form

Your TV has four screen forms: **16:9**, **4:3**, **Panorama**, **Zoom1**, **Zoom2**. (For more detail description for these modes, refer to the next page.)

- 1 Press Menu/Set button to display the main OSD menu.
- 2 Select the Picture main menu.
- 3 Press  button to enter the picture menu.
- 4 Select **Screen Form** and press  button to enter the sub menu. Then the screen form under menu appear.
- 5 Select the Screen Form you want and press  button and Exit button.

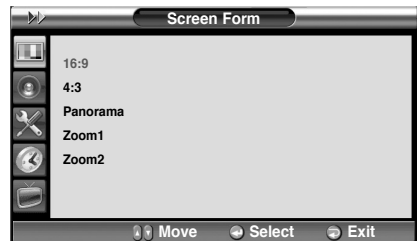
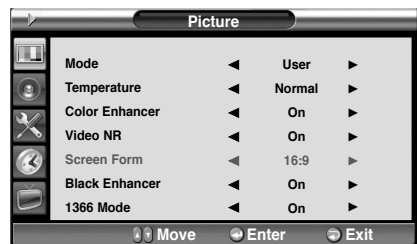

Notes

- *Panorama Screen Form is not available for COMPONENT1-2, PC RGB, DVI, HDMI input source.*
- *PC RGB, DVI, HDMI input source use 4:3 or 16:9 Screen Form.*



Setting the Picture

Screen Form Description

16:9

16:9 video : No change.

4:3 video : Expands 4:3 video signal horizontally to fit the 16:9 screen.

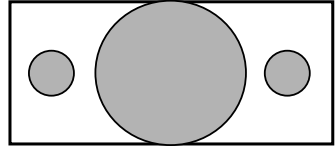

Panorama

16:9 video : No change.

4:3 video : Expands 4:3 video horizontally to fit the 16:9 screen and to minimize distortion, sides are expanded more than center.

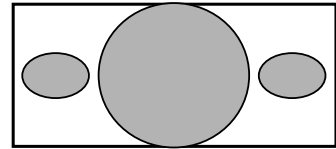

Zoom1

Expands 16:9 mode screen vertically.

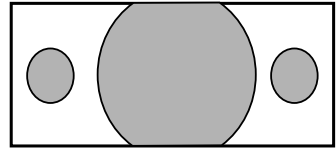

Zoom2

Expands Zoom 1 mode screen vertically.

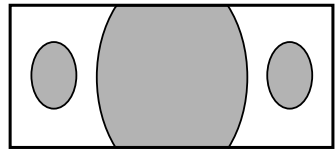

4:3

16:9 video : The image is suppressed.

4:3 video : No expansion.

There are gray areas besides the image.

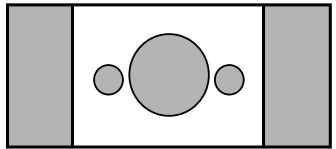

Selecting the Black Enhancer

This will enhance the black level / the contrast of the picture. The dark regions of the picture are made darker, while bright areas remain unchanged.

The advantage of this black-level expansion is that the black expansion is performed only if it is noticeable to the viewer.

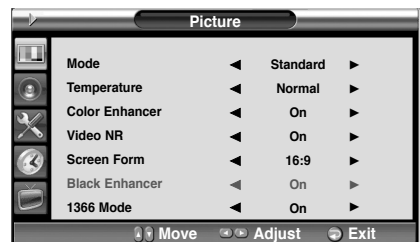



Setting the Picture (PC)

In PC Mode, you can adjust the H, V-Position, Divide, Phase and Auto Adjust. Also you can adjust them automatically.



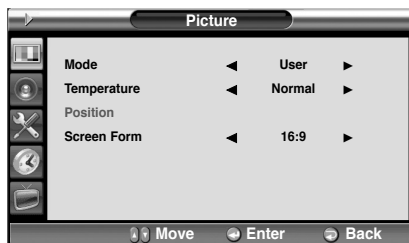

Position

You can change H, V-Position, Divide and Phase in PC mode like usual PC monitors. You can also adjust them automatically. (Auto adjust function.)

- 1 Press Menu/Set button to display the main OSD menu.
- 2 Select the Picture main menu with  /  button.
- 3 Press Menu/Set button to enter the sub menu.
- 4 Select **Position** and press Menu/Set button to enter the under menu. Then the picture-position under menu will appear.



Auto Adjust

- 1 Select the item to adjust with  /  button.
- 2 Press Menu/Set button.
- 3 Then the cursor moves on the bar and you can adjust the value with  /  button.
- 4 To adjust these items, automatically, select **Auto Adjust** and press Menu/Set button.



For more detail description refer to the next page.

Setting the Picture (PC)

▶ H-Position

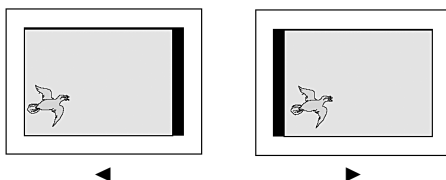

▶ V-Position

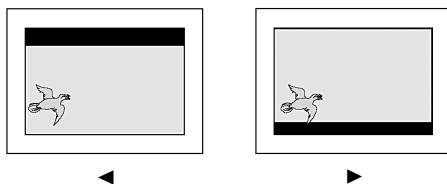

▶ Phase

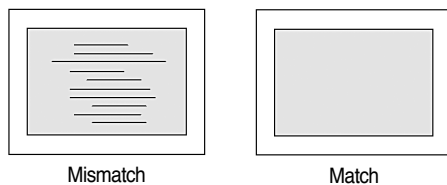

1366 Mode (Native Mode)

The menu is displayed on PC Mode.

1024 x 768 will be recognized under "Off" condition and 1366 x 768 under "On" when 1366 x 768 signal input.

- 1 Move to 1366 Mode with cursor indicating On/Off mode.
- 2 Choose "On or Off" by cursor

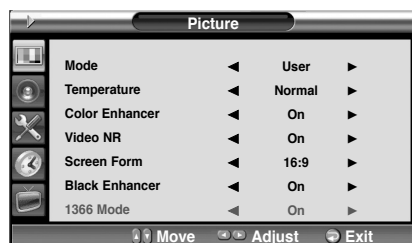

Setting the Sound

In Sound Menu, you can adjust balance, MTS (Multi-Track Sound), AVC (Auto Volume Control) and select the equalizer settings.

Adjusting the Sound Balance

This control allows you to adjust the balance of the left and right speaker output.

- 1 Press Menu/Set button to display the main OSD menu.
- 2 Select the Sound main menu.
- 3 Press Menu/Set button to enter the sub menu.
- 4 Select **Balance** and press Menu/Set button.
- 5 Adjust the Balance with ◀ ▶ button and press Exit button.

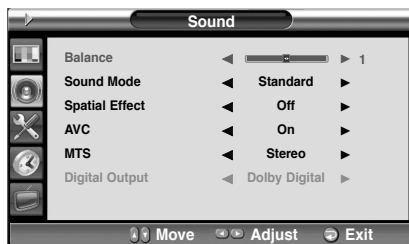

Changing the Sound Mode

Your TV has four automatic sound settings (**Standard, Movie, Music and News**) that are preset at the factory. You can activate either Standard, Movie, Music, or News by pressing Sound on the remote control (or by making a selection from the menu) or you can select **User** which automatically recalls your personalized sound settings.

- 1 Press Menu/Set button to display the main OSD menu.
- 2 Select the Sound main menu.
- 3 Press Menu/Set button to enter the sub menu.
- 4 Select **Sound Mode** and press Menu/Set button to enter the sub menu. Then the mode sub menu appear.
- 5 Select the **User** setting and press Menu/Set button.
- 6 You will see the equalizer bars. Just press Exit button on the remote control. You can adjust each values of equalizer, but the changed values are values of **User** mode.







**User mode require more settings.
It has sub menu: See next page.**

Setting the Sound

User Adjust



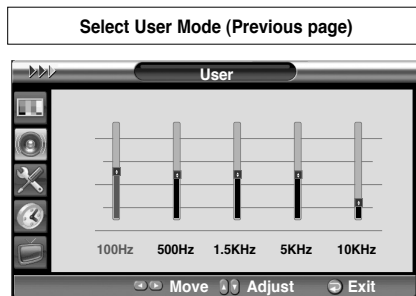

You can use the OSD menu to change the Treble, Bass, Balance, and DRC according to your preference.

- 1 Equalizer menu appear when you select User mode.
- 2 Select a gain bar with  /  button on the remote control and adjust it with  /  button.
- 3 Press Exit button on the remote control to exit equalizer. The result will be saved automatically.



Spatial Effect





This function can create surround effect such as the sound seems to come from all directions.

- 1 Press Menu/Set button to display the main OSD menu.
- 2 Select the Sound main menu item with  /  button.
- 3 Press Menu/Set button to enter the sub menu.
- 4 Select **Spatial Effect** and press  button.
- 5 Turn on or off Spatial Effect function with  /  button and press Exit button.



AVC (Auto Volume Control)

This function adjust sound volume level automatically depending on the source.



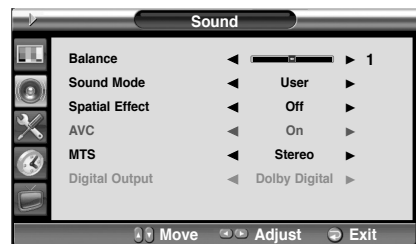

- 1 Press Menu/Set button to display the main OSD menu.
- 2 Select the Sound main menu.
- 3 Press Menu/Set button to enter the sub menu.
- 4 Select **AVC**. Then the cursor moves into the   parts.
- 5 Turn on or off AVC function with  /  button and press Exit button.



Setting the Sound

MTS (Multichannel Television Sound)

Select sound signal format from the input source. There are **Mono**, **Stereo**, **SAP** sound formats.

- 1 Press Menu/Set button to display the main OSD menu.
- 2 Select the Sound main menu with  /  button on the remote control.
- 3 Press Menu/Set button to enter the sub menu.
- 4 Select **MTS** and press Menu/Set button to enter the sub menu. Then the MTS sub menu appear.
- 5 Select the MTS format with  /  and press Menu/Set button.



The available sound formats are displayed. Usually, you can see Mono and Stereo.

MTS (Multichannel Television Sound) supports english, french and spanish. The available languages vary according to TV programs from broadcasting stations. (HDTV mode Only)



Digital Output (HDTV Mode Only)

Use this menu to select Sound Type, **PCM** or **Dolby Digital** on SPDIF Output mode.

- 1 Press Menu/Set button to display the main OSD menu.
- 2 Select the Sound main menu with  /  button on the remote control.
- 3 Press Menu/Set button to enter the sub menu.
- 4 Select **Digital Output** and press Menu/Set button to enter the sub menu. Then the Digital Output sub menu appear.
- 5 Select the **PCM** or **Dolby Digital** and press Exit button.

Select **PCM** for general speakers L, R and select **Dolby Digital** for 5.1 channel speakers system.



Notes (Optional)

 **DOLBY DIGITAL** *Dolby Trademark Acknowledgement and License Notice:*

Manufactures under license from Dolby Laboratories. "Dolby" and the double-D symbol are trademarks of Dolby Laboratories.





Setting the Others

In Setup Menu, you can adjust the transparency of the OSD menu and set PIP and others.

Adjusting the Transparency of the OSD Window

Adjust the transparency of the OSD menu. There are 8 step from 0 to 7.

- 1 Press Menu/Set button to display the main OSD menu.
- 2 Select the Setup main menu with  button on the remote control.
- 3 Press Menu/Set button to enter the sub menu.
- 4 Select **Transparency** menu. Then the cursor moves into the  parts.
- 5 Adjust with  button and press Exit button.



PIP (Picture in Picture)

You can watch two programs or sources at the same time. And Setup PIP size and position.

- 1 Press Menu/Set button to display the main OSD menu.
- 2 Select the Setup main menu with  button on the remote control.
- 3 Press Menu/Set button to enter the sub menu.
- 4 Select **PIP** and press Menu/Set button to enter the sub menu. Then the PIP sub menu appear.



PIP Window



Setting the Others

Changing the Size in PIP

Change the size of the PIP window. There are 3 sizes: Small, Large, Twin.

- 1 Select **Size** and press button.
- 2 Adjust size function with button and press Menu/Set button.



Small



Large



Twin

Changing the Source in PIP

Change the source of the PIP window.

- 1 Select **Source** and press Menu/Set button to enter the sub menu. Then the PIP sub menu appear.
- 2 The available sources will be displayed. Select the source and press Menu/Set button.



PIP	Main	TV	HDTV	VIDEO1	VIDEO2	S-VIDEO/AV	COMPONENT1	COMPONENT2	PC	DVI	HDMI
TV	-	✓	✓	✓	✓	✓	✓	✓	✓	✓	✓
HDTV	✓	-	✓	✓	✓	✓	✓	-	✓	✓	✓
VIDEO1	✓	✓	-	✓	✓	✓	✓	✓	✓	✓	✓
VIDEO2	✓	✓	✓	-	✓	✓	✓	✓	✓	✓	✓
S-VIDEO/AV	✓	✓	✓	✓	-	✓	✓	✓	✓	✓	✓
COMPONENT1	✓	✓	✓	✓	✓	-	✓	✓	✓	✓	✓
COMPONENT2	✓	-	✓	✓	✓	✓	-	✓	✓	✓	✓
PC	✓	✓	✓	✓	✓	✓	✓	-	-	-	-
DVI	✓	✓	✓	✓	✓	✓	✓	✓	-	-	-
HDMI	✓	✓	✓	✓	✓	✓	✓	✓	-	-	-

Setting the Others





► Picture Swap in PIP (Picture in Picture)

Swap the sources of the main screen and the PIP window.

Select Picture Swap and press Menu/Set button.

► Position in PIP



Change the position of the PIP window.

- 1 Select **Position** with  /  button on the remote control and press Menu/Set button to enter the sub menu. Then the PIP sub menu appear.
- 2 In sub menu, there are four positions. Select the position with  /  button on the remote control and press Exit button.



V-Chip (TV Parental Guidelines)

Parental restrictions can be Setup using either of two methods: The TV guidelines or the MPAA rating.

- 1 Press Menu/Set button to display the main OSD menu.
- 2 Select the Setup main menu with  /  button on the remote control.
- 3 Press Menu/Set button to enter the sub menu.
- 4 After enter the password, the **V-Chip** sub menu appear.



Notes

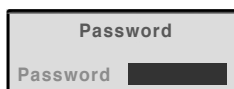

The factory default number is 0000 and the master button number is 9673.

TV Block in V-Chip

You can Setup restrictions using the “TV Parental Guidelines” of Fcc.

- 1 Select **TV Block** with button on the remote control and press Menu/Set button to enter the sub menu. Then the **TV Block** sub menu appear.
- 2 You can independently lock the TV ratings. The locked TV (FCC) ratings are indicated by the symbol.
- 3 Press button and the Menu/Set button to activate the appropriate restrictions for TV (FCC) rating system.



Notes

These categories consist of two separate groups: **TV-Y** and **TV-Y7** (Young children through age 7 (and TV-G through **TV-MA** (everybody else).

The restrictions for these two groups work independently: If a household includes very young children as well as young adults, the TV guidelines must be Setup separately for each age group.

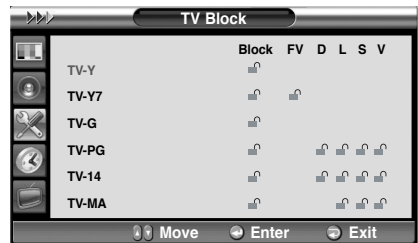
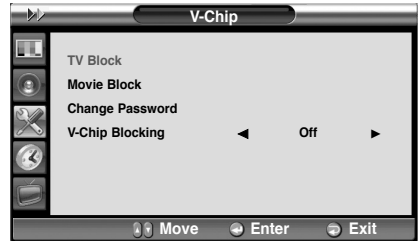

Movie Block in V-Chip

The Movie Block uses the motion picture association of America (MPAA) system, and its main application is for movies. When the rating controls is on, the TV will automatically block any programs that are coded with objectionable ratings (either MPAA or TV-Ratings).

- 1 Select **Movie Block** with button on the remote control and press Menu/Set button to enter the sub menu. Then the **Movie Block** sub menu appear.
- 2 You can independently lock the TV ratings. The locked TV (FCC) ratings are indicated by the symbol.
- 3 Press buttons and the Menu/Set button to activate the appropriate restrictions for MPAA rating system.

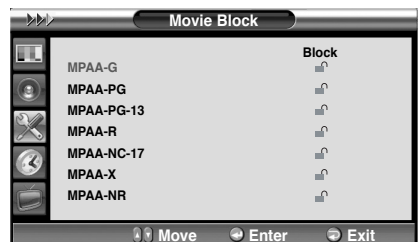
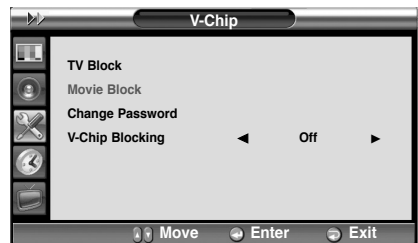



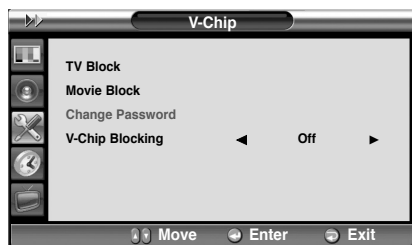

Setting the Others

Change Password in V-Chip

- 1 Select **Change Password** with  button on the remote control and press Menu/Set button to enter the sub menu. Then the Password change sub menu appear.
- 2 Enter the new password with numeric buttons on then remote control.



V-Chip Blocking in V-Chip

- 1 Select **V-Chip Blocking** with  button on the remote control.
- 2 Enter to the  part by pressing button. Then the  moves cursor into the  parts.
- 3 **On** or **Off** the **V-Chip Blocking** with  buttons.
- 4 Exit with Exit button on the remote control.



Advanced

You can Set ID, Blue Back, Language and Front Key Lock in Advanced menu.

- 1 Press Menu/Set button to display the main OSD menu.
- 2 Select the Setup main menu with  button on the remote control.
- 3 Press Menu/Set button to enter the sub menu.
- 4 Select **Advanced** and press Menu/Set button to enter the advanced menu. Then the **Advanced** sub menu appear.



Set ID in Advanced

Set the ID of TV for mass-controlling through the serial port.

- 1 Select **Set ID** menu. Then the cursor moves into the ◀▶ part.
- 2 Adjust with ◀/▶ button and press Exit button.

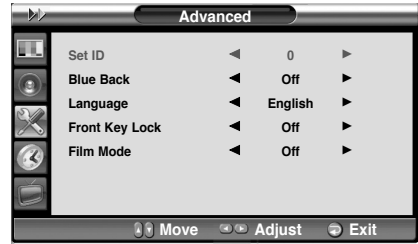

Blue Back in Advanced

You can set to display blue-color screen instead of noise screen.

- 1 Select **Blue Back** menu. Then the cursor moves into the ◀▶ part.
- 2 Turn the function on or off with ◀/▶ button and press Exit button.



Language in Advanced

Set the language to use in OSD.
Supported languages are English, French, Spanish.

- 1 Select **Language** and press Menu/Set button.
- 2 Choose the Language with ◀/▶ button and press Exit button.



Front Key Lock in Advanced

Lock the OSD panel of the TV. It can protect the TV from children's power On/Off or other operation by miss.

- 1 Select **Front Key Lock** and press ◀ button to enter the ◀▶ parts. Then the cursor moves into the ◀▶ parts.
- 2 Turn the function on or off with ◀/▶ button and press Exit button.



Setting the Others



▶ Film Mode

- 1 Select **Film Mode** by pressing the cursor to choose “ON/OFF”
- 2 Select “Off/On” with cursor.



HDTV Setup (HDTV Mode)





Use this menu to set Time zone and put daylight saving time into effect.

- 1 Press Menu/Set button to display the main OSD menu.
- 2 Select the Setup main menu with  /  button on the remote control.
- 3 Press Menu/Set button to enter the sub menu.
- 4 Select **HDTV Setup** and press Menu/Set button to enter the HDTV Setup menu. Then the **HDTV Setup** sub menu appear.



Time Zone in HDTV Setup (HDTV Mode)





Use this menu to select or change Time Zone in the US.

- 1 Select **Time zone** menu and press  button to enter the  part. Then the cursor moves into the  part.
- 2 Choose the Time Zone with  /  button and press Exit button.



Daylight in HDTV Setup (HDTV Mode)

Use this menu to adopt Daylight Saving Time.

- 1 Select **Daylight** menu and press  button to enter the  part. Then the cursor moves into the  part.
- 2 Choose the **Daylight** with  /  button and press Exit button.



Setting the Others



HDCCD Setup (HDTV Mode Only)

Use this menu to select a font style, a font type, a text color, a back color, a edge type, a edge color and a display type of subtitles.

- 1 Press Menu/Set button to display the main OSD menu.
- 2 Select the Setup main menu with  button on the remote control.
- 3 Press Menu/Set button to enter the sub menu.
- 4 Select **HDCCD Setup** and press Menu/Set button to enter the HDCCD Setup menu. Then the HDCCD Setup sub menu appear.



HDCCD Setup





- Font Style : Select a font style. (Default, Serifmono, Serif, Sanserifmono, Casual, Cursive)
- Font Type : Select a font type. (Normal, small, Large)
- Text Color : Select a text color. (Black, White, Green, Blue, Yellow, Magenta)
- Back Color : Select a back color. (Black, White, Green, Blue, Yellow, Magenta)
- Edge Type : Select an edge type. (None, Raised, Depressed, Uniform, Drop-Shadow)
- Edge Color : Select an edge color. (Black, White, Green, Blue, Yellow, Magenta)
- Display Type: Select a display type.
 - Origin: Normal display of subtitles from broadcasting stations.
 - User : User's display set on HDCCP setup menu.

Setting the Time

In the Time Menu, you can set the current time and auto power On/Off.

Setting the Current Time









Set the current time.

- 1 Press Menu/Set button to display the main OSD menu.
- 2 Select the Time main menu.
- 3 Press Menu/Set button to enter the sub menu.
- 4 Select **Time Set** by pressing  button.
- 5 Move the cursor by pressing  /  button and adjust time by  button.



Setting the On Time

This TV can be set to turn on automatically at specific time that you choose. Before using the timer, you must set the TV's Time as described previously.

- 1 Press Menu/Set button to display the main OSD menu.
- 2 Select the Time main menu with  /  button on the remote control.
- 3 Press Menu/Set button to enter the sub menu.
- 4 Select **On Time** with  /  button and press  button.
- 5 Move the cursor by  /  button and adjust time by  button.

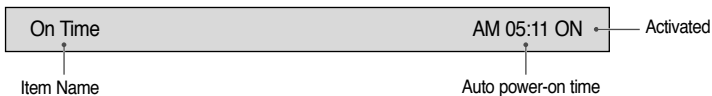



Setting the Time

Setting the On Channel

Set the channel when the TV power turn on automatically.

Available only when the time is set and On Time is ON.



- 1 Press Menu/Set button to display the main OSD menu.
- 2 Select the Time main menu with  button on the remote control.
- 3 Press Menu/Set button to enter the sub menu.
- 4 Select **On Channel**.
- 5 Then the cursor moves into the  parts.
- 6 Adjust the channel with  button. Press Exit button to return.



Setting the On Volume

Set the sound volume level when the TV power on automatically.





Available only when the time is set and On Time is ON.

- 1 Press Menu/Set button to display the main OSD menu.
- 2 Select the Time main menu with  button on the remote control.
- 3 Press Menu/Set button to enter the sub menu.
- 4 Select **On Volume**.
- 5 Then the cursor moves into the  parts.
- 6 Adjust the sound volume level with  button.



Setting the Off Time

This TV can be set to turn off automatically at specific times that you choose. Before using the timer, you must set the TV's clock as described previously.



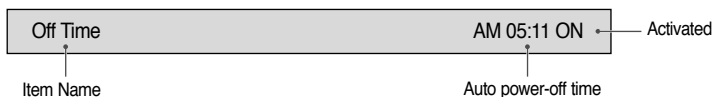

- 1 Press Menu/Set button to display the main OSD menu.
- 2 Select the Time main menu with  button on the remote control.
- 3 Press Menu/Set button to enter the sub menu.
- 4 Select **Off Time** with  button on the remote control and press  button.
- 5 Move the cursor with  button and adjust time with  button.



Setting the Sleep Timer

You can set your the TV to automatically turn off after a preset interval.

If you turn off the TV in the state of setting up sleep time and turn on again, sleep time erased therefore Setup again. The time period runs from OFF (0 min) to 180 min. (OFF, 10 min, 20, 30, 60, 90, 120, 150, 180)

- 1 Press Menu/Set button to display the main OSD menu.
- 2 Select the Time main menu with  button on the remote control.
- 3 Press Menu/Set button to enter the sub menu.
- 4 Select **Sleep** with  button on the remote control press  button.
- 5 Then the cursor moves into the  parts.
- 6 Set the time period with  button. Press Exit button to return.





OSD Menu Tree

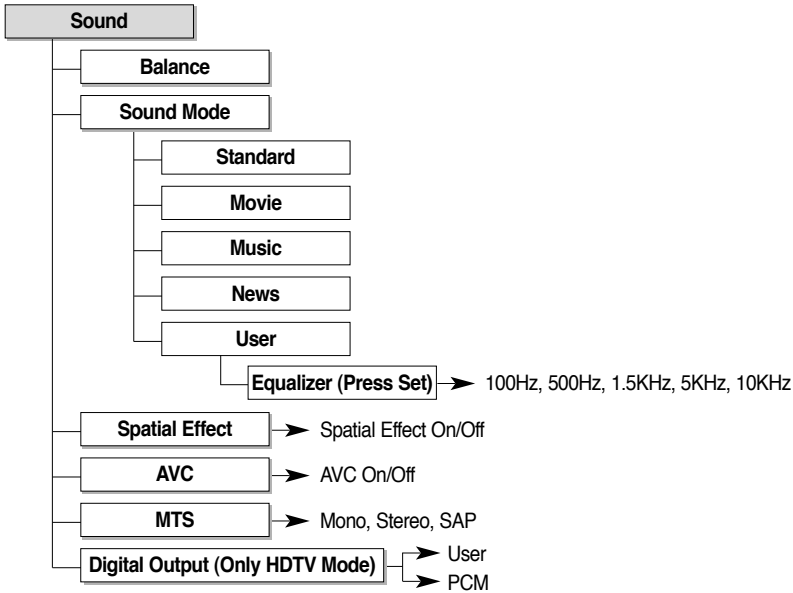
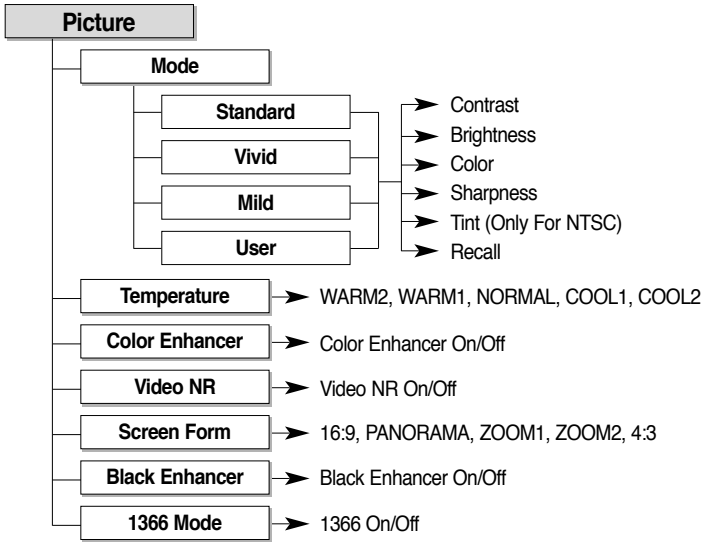

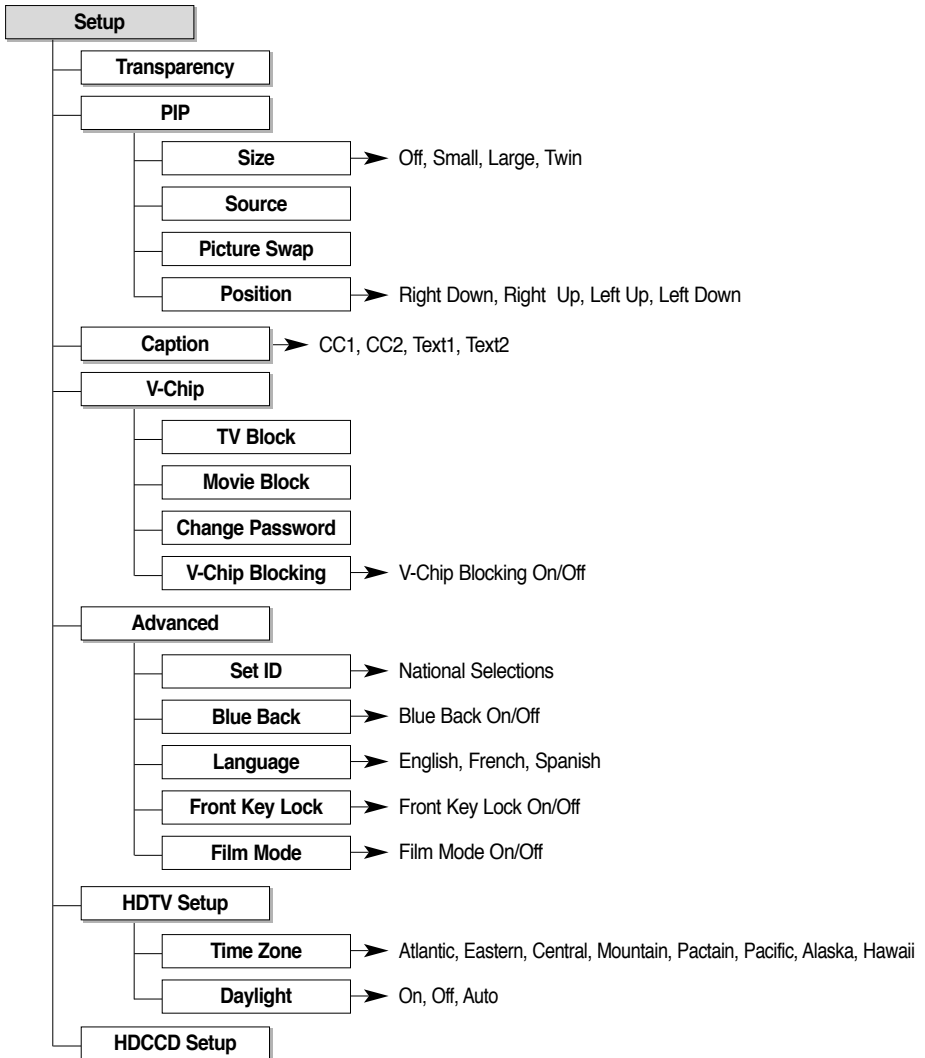



OSD Menu Tree

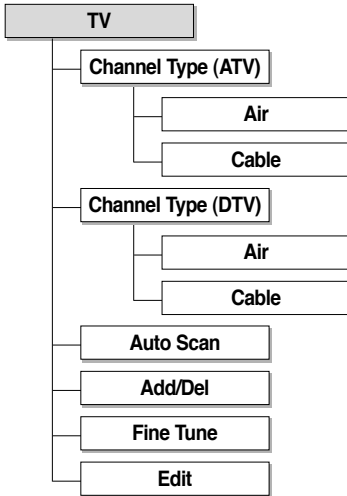
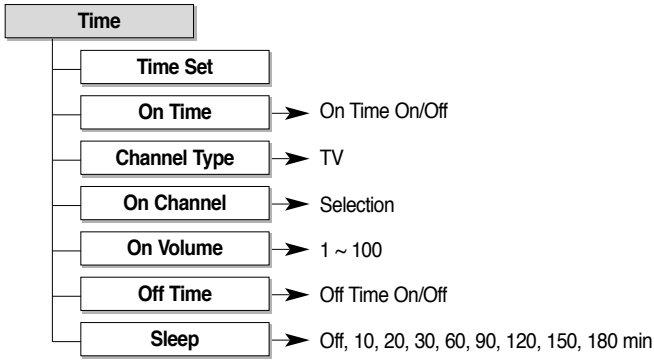

PC MODE

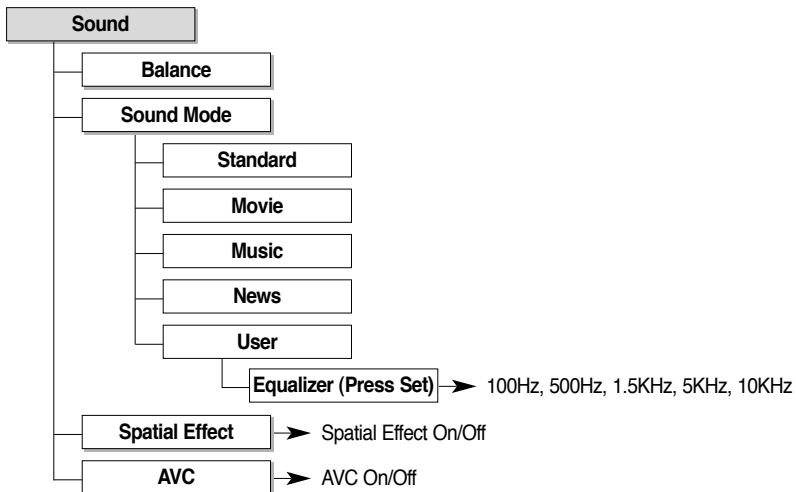
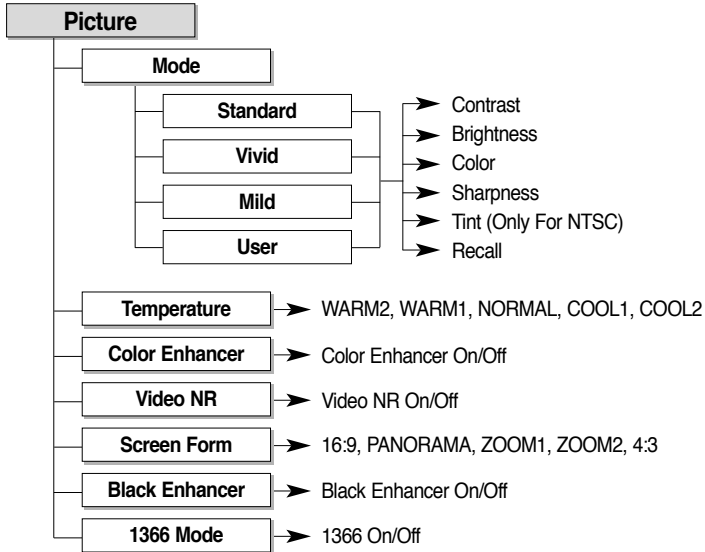



OSD Menu Tree

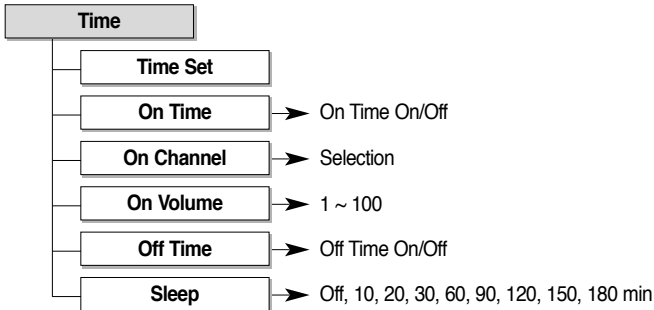
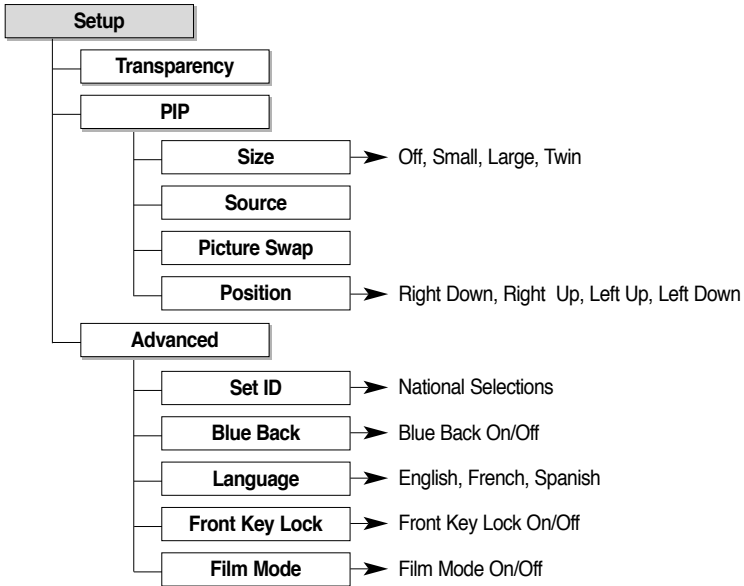



If your TV is not working properly, please scan this list of problems and possible solutions. It may save you time and money.

Problem	Quick Action for Possible Solution
No picture & No sound	<ul style="list-style-type: none"> • Check whether the TV is turned on. • Power cord inserted into wall outlet? • Plug another product's power cord into the wall outlet where the TV's power cord was plugged in.
Picture Ok & No sound	<ul style="list-style-type: none"> • Press the VOL (^) button. • Check the audio input signal.
The remote control doesn't work	<ul style="list-style-type: none"> • Check to see if there is any object between the Plasma Display and the remote control causing obstruction. • Check to see if the batteries are installed with the correct polarities.
Digital broadcasting screen problem	<ul style="list-style-type: none"> • Check the digital signal strength and input antenna.
No or poor color or poor picture	<ul style="list-style-type: none"> • Select color in the picture and press  button. • Keep a certain distance between the TV and the VCR. • Activate any function to restore the brightness of the picture. • Check to see that both the TV and the source are plugged in and turned on.
The image is too light or too dark	<ul style="list-style-type: none"> • Adjust the brightness or contrast settings.
The image is too large or too small	<ul style="list-style-type: none"> • Adjust the size settings.
No output from one of the speakers	<ul style="list-style-type: none"> • Adjust Balance in the sound menu.
Strange sound from the TV	<ul style="list-style-type: none"> • Typical sound due to normal TV operation, TV is not faulty.

Specification - 32" LCD

32" LCD TV

Function and Display Specification

Display Size	32-Inch 16 : 9 Diagonal Screen
Display Mode	Variable 5 Modes (4:3 Mode / 16:9 X 4 Modes)
Pixel Format	1366 X 768 Physical Pixel
Contrast Ratio	500 : 1
Brightness	500 cd/m ²
Max Input Resolution	1280 X 1024 / 60Hz
PIP	Advanced multi-windows viewing PIP (picture in picture) with four selectable window positions on Video mode
Input Compatible	Multiple input compatible
Video	Advanced motion digital/Motion-Adaptive De-interlace process, Digital progressive line scaling.
Tuner Module	TV/CATV (ATSC)
Programming	Favorite channel programming, Time Set, Set the Sleep timer
HDTV Input	480i/p (60Hz), 576i/p (50Hz), 720p (50/60Hz), 1080i (50/60Hz)
Color Temperature	Selectable 5 Mode (Warm1, 2, Normal, Cool1, 2)

Dimension/Weight

Main Only	792mm (W) X 486.6mm (H) X 101mm (D) / 18 kg
With Stand	792mm (W) X 554.6mm (H) X 270mm (D) / 20 kg
With Stand and Speaker	992mm (W) X 554.6mm (H) X 270mm (D) / 24 kg

Miscellaneous

Audio	Built-in amplifier and two speaker (7Watt/Typ.) systems (optional), Selectable fixed/variable audio output (optional)
External Control	Front OSD Key Control, Remote Control, RS232C Control

Power Consumption

Input Power	AC 100 ~ 240V 50/60Hz
Power Consumption	150 Watt (Max)

Connectivity

TV1, 2 Input	RF/CATV (ATSC)
Composite Input/Output	RCA X 4Port (AV Inpu 1, 2, 3 / AV Output 1)
COMPONENT1, 2 Input	RCA X 2Port (Y, Pb/Cb, Pr/Cr: 480i, 480p, 576i, 576p, 720p, 1080i)
S-VIDEO Input	Mini Din 4Pin X 1Port
PC Input	Mini D-Sub 15Pin X 1Port / HDTV Input (480p, 576p, 720p (50/60Hz), 1080i (50/60Hz))
DVI Input (DVI-D)	Mini D-Sub 29Pin X 1Port / HDTV Input (480p, 576p, 720p (50/60Hz), 1080i (50/60Hz))
AUDIO Input/Output	RCA X 6Port
Speaker Output	Cinch Type X 4Port (Stereo L/R), Head Phone Jack X 1Port
External Control Port	Mini D-Sub 9Pin X 1Port
HDMI Port	HDMI X 1Port
SPDIF Port	SPDIF (Optical) X 1Port (5.1 Channel)

Specification - 37" LCD



37" LCD TV

Function and Display Specification

Display Size	37-Inch 16 : 9 Diagonal Screen
Display Mode	Variable 5 Modes (4:3 Mode / 16:9 X 4 Modes)
Pixel Format	1366 X 768 Physical Pixel
Contrast Ratio	500 : 1
Brightness	500 cd/m ²
Max Input Resolution	1280 X 1024 / 60Hz
PIP	Advanced multi-windows viewing PIP (picture in picture) with four selectable window positions on Video mode
Input Compatible Video	Multiple input compatible Advanced motion digital/Motion-Adaptive De-interlace process, Digital progressive line scaling.
Tuner Module	TV/CATV (ATSC)
Programming	Favorite channel programming, Time Set, Set the Sleep timer
HDTV Input	480i/p (60Hz), 576i/p (50Hz), 720p (50/60Hz), 1080i (50/60Hz)
Color Temperature	Selectable 5 Mode (Warm1, 2, Normal, Cool1, 2)

Dimension/Weight

Main Only	914.6mm (W) X 556.8mm (H) X 101 mm (D) / 24 kg
With Stand	914.6mm (W) X 625mm (H) X 270mm (D) / 26 kg
With Stand and Speaker	1114.6mm (W) X 625mm (H) X 270mm (D) / 30 kg

Miscellaneous

Audio	Built-in amplifier and two speaker (7Watt/Typ.) systems (optional), Selectable fixed/variable audio output (optional)
External Control	Front OSD Key Control, Remote Control, RS232C Control

Power Consumption

Input Power	AC 100 ~ 240V 50/60Hz
Power Consumption	180 Watt (Max)

Connectivity

TV1, 2 Input	RF/CATV (ATSC)
Composite Input/Output	RCA X 4Port (AV Inpu 1, 2, 3 / AV Output 1)
COMPONENT1, 2 Input	RCA X 2Port (Y, Pb/Cb, Pr/Cr: 480i, 480p, 576i, 576p, 720p, 1080i)
S-VIDEO Input	Mini Din 4Pin X 1Port
PC Input	Mini D-Sub 15Pin X 1Port / HDTV Input (480p, 576p, 720p (50/60Hz), 1080i (50/60Hz))
DVI Input (DVI-D)	Mini D-Sub 29Pin X 1Port / HDTV Input (480p, 576p, 720p (50/60Hz), 1080i (50/60Hz))
AUDIO Input/Output	RCA X 6Port
Speaker Output	Cinch Type X 4Port (Stereo L/R), Head Phone Jack X 1Port
External Control Port	Mini D-Sub 9Pin X 1Port
HDMI Port	HDMI X 1Port
SPDIF Port	SPDIF (Optical) X 1Port (5.1 Channel)

Specification - 37" LCD (Plastic Model)

37" LCD TV (Plastic Model)

Function and Display Specification

Display Size	37-Inch 16 : 9 Diagonal Screen
Display Mode	Variable 5 Modes (4:3 Mode / 16:9 X 4 Modes)
Pixel Format	1366 X 768 Physical Pixel
Contrast Ratio	500 : 1
Brightness	500 cd/m ²
Max Input Resolution	1280 X 1024 / 60Hz
PIP	Advanced multi-windows viewing PIP (picture in picture) with four selectable window positions on Video mode
Input Compatible Video	Multiple input compatible Advanced motion digital/Motion-Adaptive De-interlace process, Digital progressive line scaling.
Tuner Module	TV/CATV (ATSC)
Programming	Favorite channel programming, Time Set, Set the Sleep timer
HDTV Input	480i/p (60Hz), 576i/p (50Hz), 720p (50/60Hz), 1080i (50/60Hz)
Color Temperature	Selectable 5 Mode (Warm1, 2, Normal, Cool1, 2)

Dimension/Weight

Main Only	1108mm (W) X 577.5mm (H) X 103mm (D) / 30 kg
With Stand	1108mm (W) X 645.5mm (H) X 270mm (D) / 31.5 kg

Miscellaneous

Audio	Built-in amplifier and two speaker (7Watt/Typ.) systems (optional), Selectable fixed/variable audio output (optional)
External Control	Front OSD Key Control, Remote Control, RS232C Control

Power Consumption

Input Power	AC 100 ~ 240V 50/60Hz
Power Consumption	180 Watt (Max)

Connectivity

TV1, 2 Input	RF/CATV (ATSC)
Composite Input/Output	RCA X 4Port (AV Inpu 1, 2, 3 / AV Output 1)
COMPONENT1, 2 Input	RCA X 2Port (Y, Pb/Cb, Pr/Cr: 480i, 480p, 576i, 576p, 720p, 1080i)
S-VIDEO Input	Mini Din 4Pin X 1Port
PC Input	Mini D-Sub 15Pin X 1Port / HDTV Input (480p, 576p, 720p (50/60Hz), 1080i (50/60Hz))
DVI Input (DVI-D)	Mini D-Sub 29Pin X 1Port / HDTV Input (480p, 576p, 720p (50/60Hz), 1080i (50/60Hz))
AUDIO Input/Output	RCA X 6Port
Speaker Output	Cinch Type X 4Port (Stereo L/R), Head Phone Jack X 1Port
External Control Port	Mini D-Sub 9Pin X 1Port
HDMI Port	HDMI X 1Port
SPDIF Port	SPDIF (Optical) X 1Port (5.1 Channel)

Specification - 40" LCD



40" LCD TV

Function and Display Specification

Display Size	40-Inch 16 : 9 Diagonal Screen
Display Mode	Variable 5 Modes (4:3 Mode / 16:9 X 4 Modes)
Pixel Format	1366 X 768 Physical Pixel
Contrast Ratio	800 : 1
Brightness	500 cd/m ²
Max Input Resolution	1280 X 1024 / 60Hz
PIP	Advanced multi-windows viewing PIP (picture in picture) with four selectable window positions on Video mode
Input Compatible Video	Multiple input compatible Advanced motion digital/Motion-Adaptive De-interlace process, Digital progressive line scaling.
Tuner Module	TV/CATV (ATSC)
Programming	Favorite channel programming, Time Set, Set the Sleep timer
HDTV Input	480i/p (60Hz), 576i/p (50Hz), 720p (50/60Hz), 1080i (50/60Hz)
Color Temperature	Selectable 5 Mode (Warm1, 2, Normal, Cool1, 2)

Dimension/Weight

Main Only	985mm (W) X 598mm (H) X 101.5mm (D) / 29 kg
With Stand	985mm (W) X 666mm (H) X 270mm (D) / 30.8 kg
With Stand and Speaker	1185mm (W) X 666mm (H) X 270mm (D) / 34.8 kg

Miscellaneous

Audio	Built-in amplifier and two speaker (7Watt/Typ.) systems (optional), Selectable fixed/variable audio output (optional)
External Control	Front OSD Key Control, Remote Control, RS232C Control

Power Consumption

Input Power	AC 100 ~ 240V 50/60Hz
Power Consumption	180 Watt (Max)

Connectivity

TV1, 2 Input	RF/CATV (ATSC)
Composite Input/Output	RCA X 4Port (AV Inpu 1, 2, 3 / AV Output 1)
COMPONENT1, 2 Input	RCA X 2Port (Y, Pb/Cb, Pr/Cr: 480i, 480p, 576i, 576p, 720p, 1080i)
S-VIDEO Input	Mini Din 4Pin X 1Port
PC Input	Mini D-Sub 15Pin X 1Port / HDTV Input (480p, 576p, 720p (50/60Hz), 1080i (50/60Hz))
DVI Input (DVI-D)	Mini D-Sub 29Pin X 1Port / HDTV Input (480p, 576p, 720p (50/60Hz), 1080i (50/60Hz))
AUDIO Input/Output	RCA X 6Port
Speaker Output	Cinch Type X 4Port (Stereo L/R), Head Phone Jack X 1Port
External Control Port	Mini D-Sub 9Pin X 1Port
HDMI Port	HDMI X 1Port
SPDIF Port	SPDIF (Optical) X 1Port (5.1 Channel)

Specification - 40" LCD (Plastic Model)

40" LCD TV (Plastic Model)

Function and Display Specification

Display Size	40-Inch 16 : 9 Diagonal Screen
Display Mode	Variable 5 Modes (4:3 Mode / 16:9 X 4 Modes)
Pixel Format	1366 X 768 Physical Pixel
Contrast Ratio	800 : 1
Brightness	500 cd/m ²
Max Input Resolution	1280 X 1024 / 60Hz
PIP	Advanced multi-windows viewing PIP (picture in picture) with four selectable window positions on Video mode
Input Compatible Video	Multiple input compatible Advanced motion digital/Motion-Adaptive De-interlace process, Digital progressive line scaling.
Tuner Module	TV/CATV (ATSC)
Programming	Favorite channel programming, Time Set, Set the Sleep timer
HDTV Input	480i/p (60Hz), 576i/p (50Hz), 720p (50/60Hz), 1080i (50/60Hz)
Color Temperature	Selectable 5 Mode (Warm1, 2, Normal, Cool1, 2)

Dimension/Weight

Main Only	1172mm (W) X 598mm (H) X 102mm (D) / 25 kg
With Stand	1172mm (W) X 666mm (H) X 270mm (D) / 27 kg

Miscellaneous

Audio	Built-in amplifier and two speaker (7Watt/Typ.) systems (optional), Selectable fixed/variable audio output (optional)
External Control	Front OSD Key Control, Remote Control, RS232C Control

Power Consumption

Input Power	AC 100 ~ 240V 50/60Hz
Power Consumption	180 Watt (Max)

Connectivity

TV1, 2 Input	RF/CATV (ATSC)
Composite Input/Output	RCA X 4Port (AV Inpu 1, 2, 3 / AV Output 1)
COMPONENT1, 2 Input	RCA X 2Port (Y, Pb/Cb, Pr/Cr: 480i, 480p, 576i, 576p, 720p, 1080i)
S-VIDEO Input	Mini Din 4Pin X 1Port
PC Input	Mini D-Sub 15Pin X 1Port / HDTV Input (480p, 576p, 720p (50/60Hz), 1080i (50/60Hz))
DVI Input (DVI-D)	Mini D-Sub 29Pin X 1Port / HDTV Input (480p, 576p, 720p (50/60Hz), 1080i (50/60Hz))
AUDIO Input/Output	RCA X 6Port
Speaker Output	Cinch Type X 4Port (Stereo L/R), Head Phone Jack X 1Port
External Control Port	Mini D-Sub 9Pin X 1Port
HDMI Port	HDMI X 1Port
SPDIF Port	SPDIF (Optical) X 1Port (5.1 Channel)

Specification - 42" LCD



42" LCD TV

Function and Display Specification

Display Size	42-Inch 16 : 9 Diagonal Screen
Display Mode	Variable 5 Modes (4:3 Mode / 16:9 X 4 Modes)
Pixel Format	1366 X 768 Physical Pixel
Contrast Ratio	400 : 1
Brightness	500 cd/m ²
Max Input Resolution	1280 X 1024 / 60Hz
PIP	Advanced multi-windows viewing PIP (picture in picture) with four selectable window positions on Video mode
Input Compatible Video	Multiple input compatible Advanced motion digital/Motion-Adaptive De-interlace process, Digital progressive line scaling.
Tuner Module	TV/CATV (ATSC)
Programming	Favorite channel programming, Time Set, Set the Sleep timer
HDTV Input	480i/p (60Hz), 576i/p (50Hz), 720p (50/60Hz), 1080i (50/60Hz)
Color Temperature	Selectable 5 Mode (Warm1, 2, Normal, Cool1, 2)

Dimension/Weight

Main Only	1056mm (W) X 648mm (H) X 102mm (D) / 35 kg
With Stand	1056mm (W) X 712mm (H) X 305mm (D) / 37 kg
With Stand and Speaker	1256mm (W) X 712mm (H) X 305mm (D) / 41 kg

Miscellaneous

Audio	Built-in amplifier and two speaker (7Watt/Typ.) systems (optional), Selectable fixed/variable audio output (optional)
External Control	Front OSD Key Control, Remote Control, RS232C Control

Power Consumption

Input Power	AC 100 ~ 240V 50/60Hz
Power Consumption	180 Watt (Max)

Connectivity

TV1, 2 Input	RF/CATV (ATSC)
Composite Input/Output	RCA X 4Port (AV Inpu 1, 2, 3 / AV Output 1)
COMPONENT1, 2 Input	RCA X 2Port (Y, Pb/Cb, Pr/Cr: 480i, 480p, 576i, 576p, 720p, 1080i)
S-VIDEO Input	Mini Din 4Pin X 1Port
PC Input	Mini D-Sub 15Pin X 1Port / HDTV Input (480p, 576p, 720p (50/60Hz), 1080i (50/60Hz))
DVI Input (DVI-D)	Mini D-Sub 29Pin X 1Port / HDTV Input (480p, 576p, 720p (50/60Hz), 1080i (50/60Hz))
AUDIO Input/Output	RCA X 6Port
Speaker Output	Cinch Type X 4Port (Stereo L/R), Head Phone Jack X 1Port
External Control Port	Mini D-Sub 9Pin X 1Port
HDMI Port	HDMI X 1Port
SPDIF Port	SPDIF (Optical) X 1Port (5.1 Channel)

Specification - 46" LCD

46" LCD TV

Function and Display Specification

Display Size	46-Inch 16 : 9 Diagonal Screen
Display Mode	Variable 5 Modes (4:3 Mode / 16:9 X 4 Modes)
Pixel Format	1366 X 768 Physical Pixel
Contrast Ratio	1000 : 1
Brightness	500 cd/m ²
Max Input Resolution	1280 X 1024 / 60Hz
PIP	Advanced multi-windows viewing PIP (picture in picture) with four selectable window positions on Video mode
Input Compatible	Multiple input compatible
Video	Advanced motion digital/Motion-Adaptive De-interlace process, Digital progressive line scaling.
Tuner Module	TV/CATV (ATSC)
Programming	Favorite channel programming, Time Set, Set the Sleep timer
HDTV Input	480i/p (60Hz), 576i/p (50Hz), 720p (50/60Hz), 1080i (50/60Hz)
Color Temperature	Selectable 5 Mode (Warm1, 2, Normal, Cool1, 2)

Dimension/Weight

Main Only	1118mm (W) X 672.4mm (H) X 101.5mm (D) / 48.7 kg
With Stand	1118mm (W) X 735.8mm (H) X 305mm (D) / 53.7 kg
With Stand and Speaker	1318mm (W) X 735.8mm (H) X 305mm (D) / 58.7 kg

Miscellaneous

Audio	Built-in amplifier and two speaker (7Watt/Typ.) systems (optional), Selectable fixed/variable audio output (optional)
External Control	Front OSD Key Control, Remote Control, RS232C Control

Power Consumption

Input Power	AC 100 ~ 240V 50/60Hz
Power Consumption	220 Watt (Max)

Connectivity

TV1, 2 Input	RF/CATV (ATSC)
Composite Input/Output	RCA X 4Port (AV Inpu 1, 2, 3 / AV Output 1)
COMPONENT1, 2 Input	RCA X 2Port (Y, Pb/Cb, Pr/Cr: 480i, 480p, 576i, 576p, 720p, 1080i)
S-VIDEO Input	Mini Din 4Pin X 1Port
PC Input	Mini D-Sub 15Pin X 1Port / HDTV Input (480p, 576p, 720p (50/60Hz), 1080i (50/60Hz))
DVI Input (DVI-D)	Mini D-Sub 29Pin X 1Port / HDTV Input (480p, 576p, 720p (50/60Hz), 1080i (50/60Hz))
AUDIO Input/Output	RCA X 6Port
Speaker Output	Cinch Type X 4Port (Stereo L/R), Head Phone Jack X 1Port
External Control Port	Mini D-Sub 9Pin X 1Port
HDMI Port	HDMI X 1Port
SPDIF Port	SPDIF (Optical) X 1Port (5.1 Channel)

Specification - 46" LCD (Plastic Model)

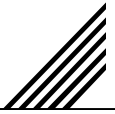

46" LCD TV (Plastic Model)

Function and Display Specification

Display Size	46-Inch 16 : 9 Diagonal Screen
Display Mode	Variable 5 Modes (4:3 Mode / 16:9 X 4 Modes)
Pixel Format	1366 X 768 Physical Pixel
Contrast Ratio	1000 : 1
Brightness	500 cd/m ²
Max Input Resolution	1280 X 1024 / 60Hz
PIP	Advanced multi-windows viewing PIP (picture in picture) with four selectable window positions on Video mode
Input Compatible	Multiple input compatible
Video	Advanced motion digital/Motion-Adaptive De-interlace process, Digital progressive line scaling.
Tuner Module	TV/CATV (ATSC)
Programming	Favorite channel programming, Time Set, Set the Sleep timer
HDTV Input	480i/p (60Hz), 576i/p (50Hz), 720p (50/60Hz), 1080i (50/60Hz)
Color Temperature	Selectable 5 Mode (Warm1, 2, Normal, Cool1, 2)

Dimension/Weight

Main Only	1305mm (W) X 672.4mm (H) X 102mm (D) / 40 kg
With Stand	1305mm (W) X 735.8mm (H) X 305mm (D) / 45 kg

Miscellaneous

Audio	Built-in amplifier and two speaker (7Watt/Typ.) systems (optional), Selectable fixed/variable audio output (optional)
External Control	Front OSD Key Control, Remote Control, RS232C Control

Power Consumption

Input Power	AC 100 ~ 240V 50/60Hz
Power Consumption	220 Watt (Max)

Connectivity

TV1, 2 Input	RF/CATV (ATSC)
Composite Input/Output	RCA X 4Port (AV Inpu 1, 2, 3 / AV Output 1)
COMPONENT1, 2 Input	RCA X 2Port (Y, Pb/Cb, Pr/Cr: 480i, 480p, 576i, 576p, 720p, 1080i)
S-VIDEO Input	Mini Din 4Pin X 1Port
PC Input	Mini D-Sub 15Pin X 1Port / HDTV Input (480p, 576p, 720p (50/60Hz), 1080i (50/60Hz))
DVI Input (DVI-D)	Mini D-Sub 29Pin X 1Port / HDTV Input (480p, 576p, 720p (50/60Hz), 1080i (50/60Hz))
AUDIO Input/Output	RCA X 6Port
Speaker Output	Cinch Type X 4Port (Stereo L/R), Head Phone Jack X 1Port
External Control Port	Mini D-Sub 9Pin X 1Port
HDMI Port	HDMI X 1Port
SPDIF Port	SPDIF (Optical) X 1Port (5.1 Channel)



ENGLISH

"RECYCLING: This product is marked by the symbol of the selective sorting, relating to the electric and electronic component scrap. That means that this product must be taken by a selective system of collection in accordance with European directive 2002/96/CE, in order to be able either to be recycled or to be dismantled in order to reduce any environmental impact. Attention ! the electronic products not having been the subject of a selective sorting are potentially dangerous for the environment and human health because of the potential presence of dangerous substances."

FRANÇAIS

"RECYCLAGE: Ce produit est marqué du symbole du tri sélectif, relatif aux déchets d'équipements électriques et électroniques. Cela signifie que ce produit doit être pris par un système de collecte sélectif conformément à la directive européenne 2002/96/CE, afin de pouvoir soit être recyclé soit être démantelé afin de réduire tout impact sur l'environnement. Attention les produits électroniques n'ayant pas fait l'objet d'un tri sélectif sont potentiellement dangereux pour l'environnement et la santé humaine en raison de la présence potentielle de substances dangereuses."

ESPAÑOL

"RECICLANDO: Este producto es marcado por el símbolo de clasificar selectivo, referente al desecho del componente eléctrico y electrónico. Eso significa que este producto se debe tomar por un sistema selectivo de la colección de acuerdo con el directorio europeo 2002/96/CE, para poder o ser reciclado o ser desmonte para reducir cualquier consecuencia para el medio ambiente. ¡ Atención! los productos electrónicos que son el tema de clasificar selectivo son potencialmente peligrosos para el ambiente y la salud humana debido a la presencia potencial de sustancias peligrosas."

ITALIANO

"RICICLANDO: Questo prodotto è contrassegnato dal simbolo della fascicolazione selettiva, concernente lo scarto del componente elettrico ed elettronico. Quello significa che questo prodotto deve essere preso da un sistema selettivo dell'accumulazione in conformità con l'indirizzamento europeo 2002/96/CE, per potere o essere riciclato o essere smontati per ridurre tutto l'impatto ambientale. Attenzione! i prodotti elettronici che sono l'argomento di fascicolazione selettiva sono potenzialmente pericolosi per l'ambiente e la salute umana a causa della presenza potenziale delle sostanze pericolose."

HET NEDERLANDS

"RECYCLEREND: Dit product wordt gemerkt door het symbool van het selectieve sorteren, met betrekking tot het elektrische en elektronische componentenschroot. Dat betekent dat dit product door een selectief systeem van inzameling overeenkomstig Europese richtlijn 2002/96/CE moet worden genomen, of kunnen worden gerecycleerd of te zijn demonteert om om het even welk milieueffect te verminderen. Aandacht! de elektronische producten die niet het onderwerp van het selectieve sorteren zijn potentieel gevaarlijk voor het milieu en de volksgezondheid wegens de potential aanwezigheid van gevaarlijke substanties. *zijn geweest

DEUTSCH

"AUFBEREITEND: Dieses Produkt wird durch das Symbol des vorgewählten Sortierens, in bezug auf den Schrott des elektrischen und elektronischen Bauelements gekennzeichnet. Das bedeutet, daß dieses Produkt durch ein vorgewähltes System der Ansammlung in Übereinstimmung mit europäischer Richtlinie 2002/96/CE genommen werden muß, um in der Lage zu sein entweder aufbereitet zu werden, oder zu sein nehmen Sie ab, um jede Klimaauswirkung zu verringern. Aufmerksamkeit! die elektronischen Produkte nicht seiend das Thema eines vorgewählten Sortierens sind möglicherweise gefährlich für das Klima und die menschliche Gesundheit wegen des potential Vorhandenseins der gefährlichen Substanzen."